

Digiroad

Description of data objects

Version 1.9



Table of contents

1	VERSION HISTORY	5
2	DEFINITIONS	7
3	INTRODUCTION	9
3.1	Structure of data in Digiroad database	9
3.1.1	Traffic element, road element	9
3.1.2	Reference chain	10
3.1.3	Segment	11
3.1.4	Identification of features	13
3.1.5	Names	13
3.2	Data services	13
3.2.1	Digiroad R	14
3.2.2	Digiroad R update	15
3.2.3	Digiroad K	15
3.2.4	Digiroad XML R	15
3.3	Coordinate reference system and height system	16
4	DATA OBJECTS OF DIGIROAD DATABASE	17
4.1	Common attribute data of data objects	17
4.1.1	Name	17
4.1.2	Validity direction	17
4.1.3	Validity lane	18
4.1.4	Validity period	18
4.2	Attribute data of traffic element	19
4.2.1	Direction of traffic flow	19
4.2.2	Name	19
4.2.3	Address numbers	19
4.2.4	Route type	19
4.2.5	Functional class	20
4.2.6	Type of road element	21
4.2.7	Municipality number	21
4.2.8	National road class	22

4.2.9 E-road number	22
4.2.10 Type of railway element	22
4.2.11 Type of ferry element	22
4.2.12 Travel time	22
4.2.13 Restriction of use of road element	22
4.2.14 Time spent for use of road element	22
4.2.15 Traffic jam sensitivity of road element	22
4.2.16 Measured length of road element	22
4.2.17 Scenic value of road element	22
4.3 Restrictions of passage on the road and street network	23
4.3.1 Blocked passage	23
4.3.2 Traffic barrier gate which can be opened	23
4.3.3 Vehicle allowed or not allowed	23
4.3.4 Maximum allowed ... x 7	24
4.3.5 Manoeuvre	25
4.4 Other attribute data of road and street network	27
4.4.1 Speed restrictions	27
4.4.2 Public transport stop	27
4.4.3 Paved road	27
4.4.4 Level crossing of a railway	28
4.4.5 Number of lanes	28
4.4.6 Road address	28
4.4.7 Bridge, underpass or tunnel	29
4.4.8 Intersection traffic light control or traffic light	29
4.4.9 Width	29
4.4.10 Built-up area	30
4.4.11 Road affected by thawing	30
4.4.12 Lit road	30
4.4.13 Directional traffic sign and its information	30
4.4.14 Construction status	32
4.4.15 Traffic volume	32
4.4.16 Speed limit during winter	32
4.4.17 Variable speed limit	32
4.4.18 Owner	32

4.4.19	Groundwater area	32
4.4.20	Pedestrian crossing	32
4.4.21	Overlapping tramline	32
4.4.22	Restriction of passage	33
4.4.23	RDS/TMC location	33
4.5	Other features	34
4.5.1	Service	34
4.5.2	Municipality	36
4.5.3	Enclosed traffic area	36
4.5.4	Junction	36
4.5.5	Specific combination of roads or routes	37
4.5.6	Train or ferry connection	37
4.5.7	Grade separated point	37
4.5.8	Town district	37
5	APPENDIX	38
<hr/>		
	APPENDIX 1: DATA OBJECTS OF THE DATABASE	39
<hr/>		
	APPENDIX 2: ELABORATION OF DATA OBJECTS	40
<hr/>		
	APPENDIX 3: FILES, FIELDS AND DESCRIPTIONS	41
<hr/>		
	APPENDIX 4: CODES	43
<hr/>		
	APPENDIX 5: TIME DOMAIN CHARACTER STRING	46
<hr/>		
	APPENDIX 6: DESCRIPTION OF DIGIROAD K DELIVERY FORMAT	49
<hr/>		
	APPENDIX 7: DESCRIPTION OF DIGIROAD XML R DELIVERY FORMAT	57
<hr/>		
	APPENDIX 8: CLASS CHART OF DIGIROAD XML R DELIVERY FORMAT	60
<hr/>		

1 Version history

Version	Date	Publication
0.5	4.3.2004	DemoCD
0.9	20.9.2004	Example deliveries
1.1	7.2.2005	Information service
1.2	1.8.2006	Information service
1.3	21.12.2006	Information service, publication 2007/1
1.4	26.3.2007	Information service, publication 2007/2
1.5	3.7.2007	Information service, publication 2007/3
1.6	17.9.2007	Information service, publication 2007/4
1.7	7.4.2008	Information service, publication 2008/2
1.8	14.9.2009	Information service, terminology translation corrected, publication 2009/4
1.9	30.12.2010	Information service, publication 2010/1

Version 0.5

This version is written for the DemoCD of Digiroad.

Version 0.9

This version is written for data examples that can be downloaded from the Digiroad web pages.

Version 1.1

This version is created for the information services of Digiroad database.

Version 1.2

This version has modifications and additions, such as definitions, code values presented with data objects and editing and additions on appendices.

Version 1.3

This version has minor modifications and additions.

Version 1.4

This version has modifications and additions mainly on data services.

Version 1.5

This version has some modifications and additions. The most important modification is the change of traffic volume from traffic element attribute to dynamically segmented attribute data.

Version 1.6

This version has some modifications and additions. The most important modification is including delivery format R update as an option of delivery.

Version 1.7

This version has some modifications and additions, e.g. railway types missing from appendix 4: Codes have been corrected.

Version 1.8

Term digital segmentation has been corrected to dynamic segmentation.

Version 1.9

Finnish Road Administration has been changed to Finnish Transport Agency as of 1st of January 2010.

2 Definitions

Attribute data

Attribute data is an entity of identifiable, timeable and descriptive properties of a feature. For example, value and validity direction of speed limit are the attribute data of a speed limit.

Centre line geometry

Digiroad centre line geometry is formed by line segments that describe the positions of centre lines of roads, streets, pedestrian and cycle lanes, railways and ferry connections.

Data object

Data object is an attribute datum of traffic network, e.g. speed limit or traffic network feature, e.g. service.

Digiroad K

Digiroad K is a delivery format of Digiroad data in which traffic elements have been disconnected into equal parts according to their attribute data .

Digiroad R

Digiroad R is a delivery format of Digiroad data which includes dynamically segmented attribute data on reference chains.

Digiroad database

Digiroad database is a national road and street database for which Finnish Transport Agency (formerly Finnish Road Administration) is responsible and which includes centre line geometry of streets and roads and attribute data linked to traffic.

Dynamic segmentation

Dynamic segmentation is an indirect way of indicating position. The position is defined by a known point on linear referencing (reference chain in Digiroad).

Indirect position

Indirect position is a position indicated with the help of grid structure, positioning marker, address or of similar one concept system.

Line segment

Line segment is a segment which has as its indirect position the distance between two measures on a reference chain. The geometric shape formed by dynamic segmentation of a line segment is a line.

Linear referencing

Linear referencing is a line geometry from which position in relation to a known point on a line can be determined, e.g. according to measure like in Digiroad.

Measure

Measure is attribute data of linear geometry which helps to define the location on a line unambiguously.

Point segment

Point segment is a segment which has as its indirect location a point on a reference chain, i.e. one measure. The geometric shape of a point segment formed by dynamic segmentation is a point.

Position data

Position data is an entity formed by geometric type of feature (point, line, area) and by coordinate data indicating the position of a feature.

Reference chain

Reference chain is the linear referencing of Digiroad.

Road and street network

Road and street network is a part of traffic network consisting of road elements without ferries and railways.

Road element

Road element is a traffic element which is not a railway or ferry element.

Segment

Segment is attribute data with indirect position indicated by dynamic segmentation. Segments have no geometric realisation of their own; instead they are located dynamically based on values of reference chain and measure.

Service

In Digiroad, service refers to a service that helps and supports the users of road and street network, e.g. a parking building or bus station.

Traffic element

Traffic element is the smallest unit of Digiroad centre line geometry. Traffic elements reach from intersection to intersection (but may also be shorter)..

Traffic network

Traffic network is an entity consisting of traffic elements linked together. There are also elements in Digiroad that are separate from the traffic network (e.g. on islands).

3 INTRODUCTION

Digiroad is a national road and street database which includes centre line geometry of streets and roads. It also includes attribute data to be used for traffic planning. Digiroad is a unified database developed by the Finnish Transport Agency (formerly Finnish Road Administration) and it contributes to the development of different transport telematic services and offers homogeneous information covering the whole Finland.

Digiroad includes vehicle accessible roads, ferry and cable ferry connections for cars, railways and separate pedestrian and cycle paths.

This document describes the structure, delivery formats and data objects of Digiroad. More about the data quality of Digiroad can be found in the quality description.

Data objects have in this description been divided into attribute data of traffic elements, traffic restrictions, other attributes of road and street network and other features.

3.1 Structure of data in Digiroad database

The centre line geometry of Digiroad network of roads and streets consists of traffic elements. Some of the data objects of Digiroad are attribute data of traffic elements. In Digiroad, the centre line geometry of road and street network is in addition to traffic elements also as reference chains. Reference chains are the linear referencing of Digiroad. Measure has been attached to the geometry of reference chains. Most of the data objects of Digiroad have been tied to reference chains using dynamic segmentation. Data objects that have been segmented dynamically do not have their own geometry, but they are located dynamically according to reference chains and measures. Digiroad data object can also be a point, e.g. a service or an area like an enclosed traffic area.

3.1.1 Traffic element, road element

Digiroad traffic network consists of traffic elements. A traffic element is the smallest unit of centre line geometry of a road, street, private road, pedestrian and cycle path, railway or ferry connection. Traffic elements cover the distance between intersections but can also be shorter. There are also road, railway and ferry elements. Railway and ferry are route types of traffic elements. Traffic element is the collective term for other route types, i.e. roads, streets, private roads and pedestrian and cycle paths. The direction of digitisation of a traffic element determines the direction of the traffic element to which the direction of traffic flow is compared.

cally based on the reference chains and measures. The measures of reference chains are reference chain specific numbers and they do not represent metres. Measures grow in the direction of digitisation of reference chains but do not always start from zero. The direction on roads is usually the direction in which the street numbers grow and on others it is the usual direction of traffic elements.

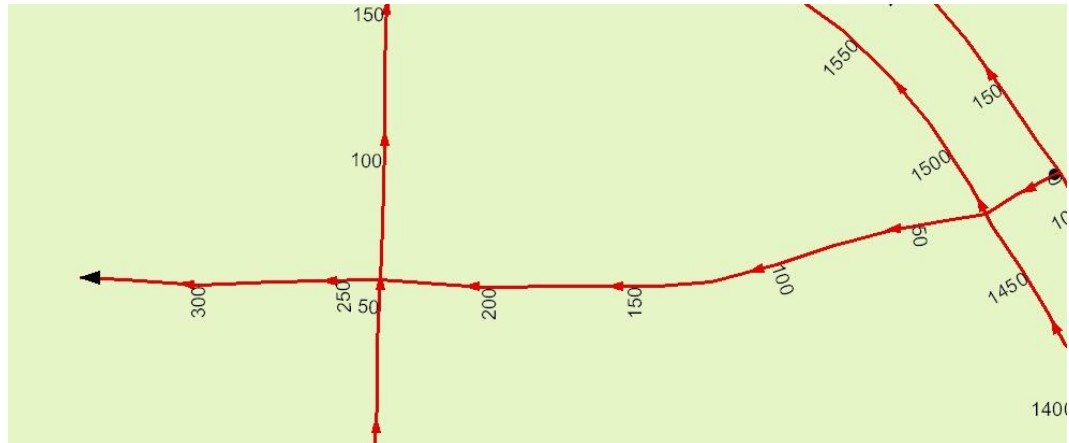

Image shows measures with geometry data of a reference chain.

3.1.3 Segment

Dynamically segmented attribute datum which is bound to a Digiroad reference chain is called a segment. Segments do not have their own geometry, they only have the information on which reference chain the segment is situated and at which point of a reference chain it is, i.e. measures at the beginning and end of a segment.

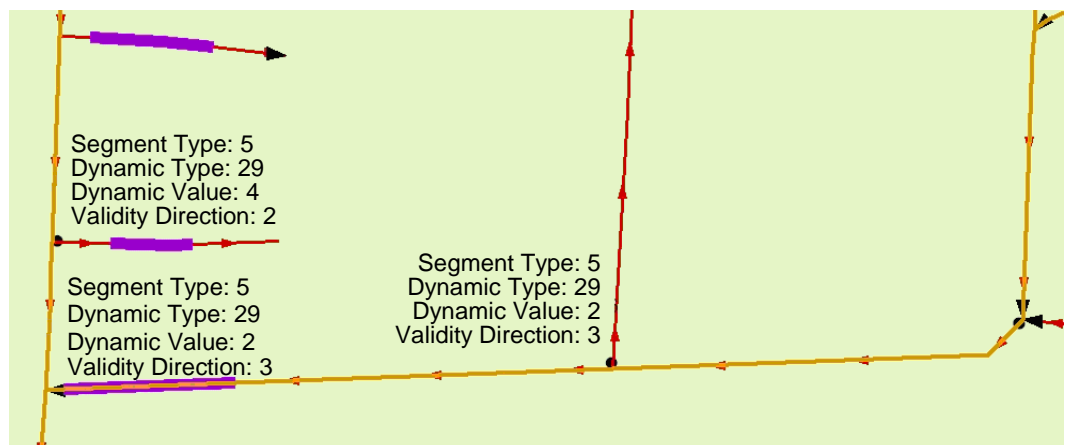

Image shows vehicle not allowed segments in purple and pavement segments in orange.

Segment is a line segment if the measure at the beginning is different from the measure at the end, e.g. pavement segment. The measures of a point segment are the same, e.g. starting and end points of a bus stop.



Point segment bus stop is at 2588,29 of a reference chain.

KETJU_OID	ALKUPISTE	LOPPUPISTE	VAIKUTUSSU	TYYPPI	DYN_TYYPPI	DYN_ARVO
12105	0,000000000000	13,740000000000	2	5	11	60
12072	661,080000000000	690,280000000000	1	5	29	12
12072	661,080000000000	690,280000000000	1	5	29	14

Data on a segment table (DIGIROAD_SEGMENTTI.dbf).

As shown in the previous example from a segment table, a segment has data of the reference chain (KETJU_OID). Measures (ALKUPISTE, LOPPUPISTE) determine the start and end points on a reference chain. The validity direction (VAIKUTUSSU) is for the first segment 2, i.e. in the direction of the digitisation of the reference chain and for the next two it is 1, i.e. both directions. The type of segment is 5, i.e. dynamic attribute. The type of dynamic attribute (DYN_TYYPPI) is 11 (speed limit) or 29 (vehicle not allowed). The value of dynamic attribute (DYN_ARVO) is for speed limit 60 km/h, for the first vehicle not allowed segment 12 (pedestrian) and for the second one 14 (tractor or farming vehicle).

In addition to location and validity direction, segments may also have a validity lane starting on the right in the validity direction, attribute data of segment type itself and validity period as Time domain character string. Further information on Time Domain character string can be found in appendix 5.

The location of a segment has no effect on the location of another segment, which means that a segment may start or finish at any point on a reference chain. Certain segment types, e.g. width may only appear once at the same point. Some other segment types may appear more than once, e.g. vehicle not allowed, because only one vehicle type can be determined in one segment.

3.1.4 Identification of features

Traffic elements, along with other features and dynamically segmented attribute data taken from Digiroad database each get their own Digiroad ID. Digiroad ID is used as a unifying factor in updated data and transfers between different systems. Digiroad ID is a GUID identifier (Globally Unique Identifier).

3.1.5 Names

All name data in Digiroad are in a separate name table. Name table holds the names of road elements and among other things names of segmented attribute data. In addition to the name text, also language code and type of name are included. One feature may have several names. Typically each road element has an official name both in Finnish and in Swedish, e.g. Muurimestarintie, Murmästarsvägen. In the system it is also possible to store an alternative, e.g. Kehä 1, Ring 1. When using name data, the most appropriate name can be chosen according to municipality's first language. Further information on languages can be found in the Government decree 1174/2002.

A name can be added to a traffic element based on `OID_tunnus` (mode R) or `VIITE_OID` (mode K) field of the traffic element and on the `LIKENNE_E` field of the name table.

A name can be added to a segment based on `OID_tunnus` (mode R) or `VIITE_OID` (mode K) field of the segment table and on the `SEGMENTTI_` field of the name table.

A name can be added to a service based on `OID_tunnus` field and `SEGMENTTI_` field of the name table.

3.2 Data services

Data from Digiroad is delivered to customers as transfer files based on the agreement between the customer and the Finnish Transport Agency (formerly Finnish Road Administration).

Digiroad database allows individual deliveries but for the time being Digiroad publishes material based on the release programme. The contents of the release programme can be changed when needed. There are four different material publications per year. Each publication contains the following:

- basic delivery Digiroad R and Digiroad K, in EUREF-FIN coordinate system, files according to regions
- basic delivery Digiroad R and Digiroad K, in EUREF-FIN coordinate system and YKJ (Finland's uniform coordinate system), files according to municipalities
- update delivery Digiroad R (in EUREF-FIN coordinate system, files according to regions) and update delivery Digiroad XML R (in EUREF-FIN coordinate system, files according to municipalities)

The delivery formats Digiroad R and Digiroad K are in ESRI shape format. Digiroad R delivery format is suitable for e.g. ESRI ArcGIS. Digiroad K delivery format is suitable for e.g. MapInfo.

3.2.1 Digiroad R

Digiroad R delivery format includes dynamically segmented attribute data on reference chains. Digiroad R is delivered in ESRI shape format.

Digiroad R can be utilised with RouteEvents function of ESRI. A route event is formed as follows:

- Route Reference: DIGIROAD_KETJU
- Route Identifier: TUNNUS
- Event Table: DIGIROAD_SEGMENTTI
- Route Identifier: KETJU_OID
- Point Events
- Measure:
 - Measure: ALKUPISTE
- Line Events
 - From-Measure: ALKUPISTE
 - To-Measure: LOPPUPISTE

–Forming a route event from Digiroad R data.

3.2.2 Digiroad R update

Digiroad R update is as a delivery format similar to Digiroad R, but it includes only the additions, changes and deletions made after the last publication.. Deletions are indicated with dbf files, which include the GUID identifiers of deleted features.

3.2.3 Digiroad K

Digiroad K is a delivery format in which traffic elements are disconnected into homogenous parts according to their attribute data. Dynamically segmented attribute data, i.e. segments, are disconnected in the same way as traffic elements. In Digiroad K delivery format the attribute data in DIGIROAD_SEGMENTTI table do not need to be located dynamically with the help of reference chains because disconnected segments have their own geometry. There are as many overlapping segments (with their own geometries) as there are segmented attribute data at a particular location. In Digiroad K delivery format the disconnected attribute data in DIGIROAD_SEGMENTTI table can be connected with disconnected traffic elements in DIGIROAD_LIIKENNE_ELEMENTTI table. This delivery format is suitable for the use with e.g. MapInfo (version 7.0 or newer). Digiroad K is delivered in ESRI shape format. More on Digiroad K delivery format in appendix 6.

3.2.4 Digiroad XML R

Digiroad XML R delivery format includes attribute data dynamically segmented on reference chains. Digiroad XML R delivery format is based on the definitions of the version 1.0 of XML. As basis for defining geometries has been the version 2.0 of GML. More on Digiroad XML R delivery format in appendix 7.

3.3 Coordinate reference system and height system

The projected coordinate system of Digiroad is EUREF-FIN. Geographic coordinates are used as storage format for position data. The height system of Digiroad traffic network is N60.

Delivery in Digiroad XML format is always in EUREF-FIN coordinate system, as geographic coordinates in decimal degrees having accuracy of six decimals. Data may in Digiroad R ja Digiroad K delivery formats also be delivered in YKJ (Finland's uniform coordinate system) in addition to EUREF-FIN coordinates. In the YKJ coordinate conversion the conversion tool offered by the National Land Survey of Finland is used. The tool is based on the Public Administration recommendation JHS 154 (2.12.2003).

Many GIS software make it possible to convert geographic coordinates into projected ones either permanently or temporarily when presenting the data. The JHS 154 includes recommendations for projections used with the EUREF-FIN coordinate system.

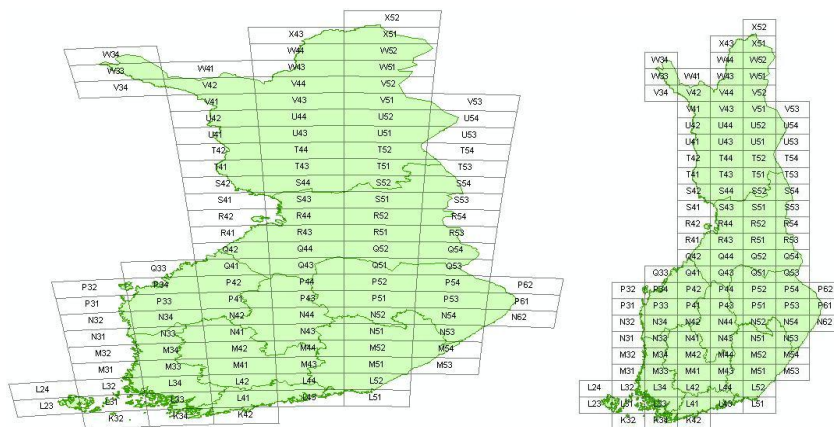

On the left an example of what Finland looks like in geographic coordinates. In the example on the right Finland has been projected.

4 Data objects of Digiroad database

The code values of data objects' attribute data can be found in the code tables in appendix 4. Code values are also presented together with data objects.

4.1 Common attribute data of data objects

4.1.1 Name

Table: DIGIROAD_NIMI

A name is any combination of letters, numbers or punctuation which forms a valid name in the language indicated by the language code.

Name data includes:

- name (name text)
- type of name (1-2)
- language code (1-2)

The code values of a name are:

- 1 Official
Official name is determined by the official organisation which is responsible for the existence and maintenance of the feature.
- 2 Alternate
Alternate name is a name used for an attribute or feature when the name has no official status, position or standing but it is widely used or known by the general public. The identifier used for the feature by the municipality can also be stored to an alternate name.

The most common language codes are:

- 1 fin Finnish
- 2 swe Swedish

4.1.2 Validity direction

Table: DIGIROAD_SEGMENTTI

Validity direction means the direction in which the attribute data is valid when using the road and street network.

In Digiroad, the validity direction of attribute data is determined by the direction of digitisation of centre line geometry. In delivery formats Digiroad R and Digiroad XML R the validity direction is expressed in relation to the direction of digitisation of a reference chain. In delivery format Digiroad K the validity direction is expressed in relation to direction of digitisation of traffic element and segment. For instance, for a bus stop, which is located on the right side in the direction of digiti-

sation, the validity direction is in the direction of digitisation. Also, for a speed limit which is valid when using the road and street network against the direction of digitisation, the validity direction is against the direction of digitisation.

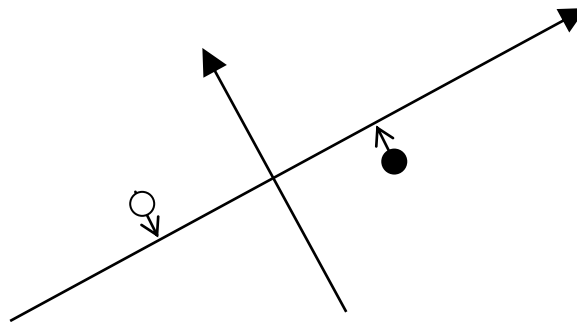

Picture shows two bus stop points. The validity direction of the black bus stop is in the direction of digitisation, because the point is located on the right side in relation to the direction of digitisation of Digiroad centre line geometry (in the direction of the longer arrow). The validity direction of the white bus stop is against the direction of digitisation, because the point is located on the left side in relation to the direction of digitisation of Digiroad centre line geometry (in the direction of the longer arrow).

The values of validity direction are:

- 1 Both directions
- 2 In the direction of digitisation
- 3 Against the direction of digitisation

4.1.3 Validity lane

Table: DIGIROAD_SEGMENTTI

Attribute data has validity lane when a carriageway has more than one lane in the validity direction and the attribute data is valid only on one of the lanes of the validity direction. More on the number of lanes in [4.4.5](#). There is no validity lane if the attribute is valid on all the lanes in the validity direction.

Certain lanes may, for instance, only allow buses. Other lanes in the same validity direction have no restrictions of vehicle type and therefore the restriction only buses allowed has to be added as validity lane data. More on data objects vehicle allowed and vehicle not allowed in [4.3.2](#).

Validity lanes are numbered starting from the first lane on the right in the validity direction (the one closest to the side of the road).

4.1.4 Validity period

Table: DIGIROAD_SEGMENTTI

Attribute data may have a validity period. Validity period is presented as Time Domain character string. There is a description of the structure of Time Domain character string in appendix 5.

4.2 Attribute data of traffic element

Tables: DIGIROAD_LIIKENNE_ELEMENTTI
DIGIROAD_NIMI

Traffic element is the smallest unit of centre line geometry of a road, street, pedestrian or cycle path, railway or ferry connection.

4.2.1 Direction of traffic flow

The direction of traffic flow is determined in relation to the direction of digitisation of a traffic element.

The values of the direction of traffic flow are:

- 2 Traffic is permitted in both directions
- 3 Traffic is permitted against the direction of digitisation
- 4 Traffic is permitted in the direction of digitisation
- 5 Traffic is closed in both directions

4.2.2 Name

Names are stored on a separate name table. Address name of a road or street is connected to traffic elements. See [4.1.1](#).

4.2.3 Address numbers

Digiroad includes the first and the last address numbers of road elements on the right and left sides. The exact positions of the numbers are not included in Digiroad.

Address numbers of houses consist of the following data:

- Structure of house numbering
- First house on the right
- First house on the left
- Last house on the right
- Last house on the left

The values of house numbering structure are:

- 2 Regular, even and uneven numbers on different sides
- 3 Regular, even and uneven numbers on the same side
- 4 No regularity

4.2.4 Route type

Traffic elements on route type are divided into roads, streets, private roads, separate cycle or pedestrian paths, ferries and railways.

Values of route type are:

- 1 Road
- 2 Street (or in practice equivalent to a street)
- 3 Private road (also the ones maintained by municipalities)
- 4 Pedestrian or cycle path
- 5 Railway
- 6 Ferry

4.2.5 Functional class

Functional class of Digiroad is based on the importance of a road or street. Functional class describes:

- service level of route to the traffic
- intention of the route maintainer to direct traffic to the route.

Functional classes of **roads** are mainly similar to the classification of the Finnish Transport Agency (formerly Finnish Road Administration).

Functional classes of **streets** may be determined by municipalities. The basis for the classification is the one used in the land use plan. If a road continues as a street, the functional class of the road affects the classification.

Regional main street serves mainly long distance or transit traffic and incoming traffic. There may also be traffic within the municipality on a regional main street.

Local main street serves mainly traffic within a municipality, e.g. from a suburb to the city centre or the traffic between different surrounding areas. There may also be long-distance, transit or incoming traffic on a local main street.

Collector street collects traffic from residential areas to main streets and roads. There should be no traffic through the residential area.

Feeder street connects the use of land to collector streets and roads. There is a direct connection from a feeder street to a plot of land or a building site.

Private roads belong to the functional classes 5 and 6.

The use of functional class 5 private road is commonly allowed and it can be used throughout the year. Typically a class 5 road is very important for the traffic in the area and there is also a road association that has been established and it has received funds from the state or municipality.

Functional class 6 includes all other private roads, including forest roads, which are not in class 5 and which are accessible by vehicles.

Cycle and pedestrian paths are included in the functional class 10.

<u>Streets</u>	<u>Functional class</u>	<u>Public roads</u>
Regional main street	1	Class I main road
	2	Class II main road
Local main street	3	Regional road
Collector street	4	Connecting road
Feeder street	5	Class I private road
	6	Class II private road
Cycle or pedestrian path	10	Cycle or pedestrian path

Functional classification of Digiroad

Values of functional class are:

- 1 Regional main street / Class I main road
- 2 Regional main street / Class II main road
- 3 Local main street / Regional road
- 4 Collector street / Connecting road
- 5 Feeder street / Class I private road
- 6 Class II private road
- 10 Cycle or pedestrian path

4.2.6 Type of road element

Type describes the physical or traffic-type attribute data, e.g. part of single carriageway or part of a roundabout.

The most common code values of road element type are:

- 1 Part of a motorway
- 2 Part of a multiple carriageway which is not a motorway
- 3 Part of single carriageway
- 4 Part of a roundabout
Parts of a roundabout are the road elements of the roundabout ring.
- 8 Slip road
Slip road is e.g. a ramp of a parallel, grade separated or roundabout junction or a one-way ramp, e.g. bus stop ramp on a motorway.
- 10 Part of a service or emergency road
- 13 Part of a pedestrian zone (e.g. a pedestrian street)
- 14 Part of a cycle path
- 17 Part of a semi-motorway

4.2.7 Municipality number

The number of the municipality in which most of the traffic element is located. By using the municipality number the traffic elements of a municipality can be chosen with the accuracy described earlier.

4.2.8 National road class

The values of national road class are:

- 1 Class I main road
- 2 Class II main road
- 3 Regional road
- 4 Connecting road

4.2.9 E-road number

4.2.10 Type of railway element

Types of railway element are railway, narrow gauge railway and underground/metro.

4.2.11 Type of ferry element

Values of type of ferry element are:

- 1 Ferry
- 2 Cable ferry

It is also possible to include the following attribute data in Digiroad database:

4.2.12 Travel time

Travel time means the time used by a ferry connection or motorail on traffic element.

4.2.13 Restriction of use of road element

The use of a road element is restricted, for instance, in industrial areas.

4.2.14 Opening period of road element

Time indicated as Time Domain character string.

4.2.15 Traffic jam sensitivity of road element

4.2.16 Measured length of road element

4.2.17 Scenic value of road element

4.3 Restrictions of passage on the road and street network

4.3.1 Blocked passage

Table: DIGIROAD_SEGMENTTI
segment type 5 / dynamic attribute type 16

Blocked passage indicates a physical obstruction which prevents the use of road and street network via that point, e.g. the connection between two streets have been cut off with a stone, a barrier gate which cannot be opened, or by a ditch. Blocked passage is a point segment.

4.3.2 Traffic barrier gate which can be opened

Table: DIGIROAD_SEGMENTTI
segment type 5 / dynamic attribute type 3

A traffic barrier gate which can be opened is a point on an uninterrupted centre line geometry that has a locked barrier gate which can be opened. Barrier gate is a point segment.

4.3.3 Vehicle allowed or not allowed

Table: DIGIROAD_SEGMENTTI
segment type 5 / dynamic attribute types 1 and 29

Vehicle not allowed segment has as its value the type of vehicle which is forbidden on the segment.

Vehicle allowed segment has as its value the type of vehicle which is allowed on the segment.

As a presumption the use of road and street network is allowed for all vehicle types. There is a vehicle allowed and vehicle not allowed segment only when there is a particular vehicle restriction on the road and street network. When there is a vehicle restriction, the use of road and street network is allowed for all types of vehicles, except the ones that are restricted. Correspondingly, as a presumption the use of road and street network is not allowed, except for the types that have specifically been allowed. For example, on a bus lane, there are no restrictions, only the vehicle allowed segment with bus as the value. In some cases there are both restrictions and vehicle allowed segments, because often, for example, motor vehicles are not allowed but driving is allowed to the lots.

There are usually several vehicle segments at the same point because on a motorway, for example, pedestrians, bicycles, mopeds and tractors are not allowed. Also, quite often driving to the lots is allowed even when no motor vehicles are allowed.

Also those vehicle types that have restricted manoeuvres are vehicle segments. Vehicle segment for a restricted manoeuvre only applies to turning traffic. Vehicle restriction has no connection to turning order if the vehicle segment applies to the use of road and street network regardless of the direction of the traffic.

Vehicle segments are line segments. The length of a vehicle segment is that of the validity area or a segment is 5-10 metres long at the sign that denotes the restriction.

Vehicle segments may have a validity period as a Time Domain character string. More on the Time Domain character string in appendix 5.

Values of vehicle type are:

- 1 All vehicles
- 2 Motor vehicle
- 3 Vehicle
- 4 Truck
- 5 Bus
- 6 Van
- 7 Passenger car
- 8 Taxi
- 9 Motorcycle
- 10 Moped
- 11 Cycle
- 12 Pedestrian
- 13 Articulated vehicle
- 14 Tractor or farm vehicle
- 15 Car with trailer/ recreational vehicle
- 16 Delivery vehicle
- 17 Emergency vehicle
- 18 Carpool (HOV) vehicle
- 19 Military vehicle
- 20 Vehicle with dangerous load
- 21 Driving in service purposes
- 22 Driving to the lots
- 23 Driving through

4.3.4 Maximum allowed ... x 7

Table: DIGIROAD_SEGMENTTI
segment type 5 / dynamic attribute types 18 - 24

Maximum allowed restrictions are:

- 18 Maximum height allowed for a vehicle
- 19 Maximum length allowed for a vehicle or articulated vehicle
- 20 Maximum total weight allowed for an articulated vehicle
- 21 Maximum weight per axle allowed for a vehicle
- 22 Maximum total weight allowed for a vehicle
- 23 Maximum width allowed for a vehicle
- 24 Maximum weight per tandem-axle allowed for a vehicle

Maximum allowed segments are line segments. Segments of maximum allowed restrictions have the same length as the restricted part of the road network, e.g. maximum height of a vehicle allowed is at the location of an underpass and maximum weight of a vehicle allowed is at the location of a bridge. When the exact point of restriction is not clear, the restriction has been defined as 5-10 metres at the sign showing the restriction, e.g. if there is a weight restriction because of the condition of a part of a road and not because of a bridge etc. Maximum height allowed for a vehicle is displayed on roads only if it is below 440 cm.

Height, length, and weight values of maximum allowed data are shown in centimetres with an accuracy of decimetres (e.g. a sign showing maximum height allowed restriction of 3,5 metres is in Digiroad displayed with the value 350). Mass values of maximum weight allowed data are in kilograms with an accuracy of hundred kilograms (e.g. a sign showing maximum weight allowed restriction of 25,5 tons is in Digiroad displayed with the value 25 500).

4.3.5 Manoeuvre

Tables: DIGIROAD_KAANTYMISMAARAYS
 DIGIROAD_KAANTYMISMAARAYS_ELEMENTTI
 DIGIROAD_SEGMENTTI_KAANTYMISMAARAYS
 DIGIROAD_SEGMENTTI

Manoeuvre indicates the compulsory, prohibited or blocked manoeuvres.

Manoeuvre consists of the type of manoeuvre, the start, intermediate, and end elements connected to manoeuvre and possible validity period as a Time Domain character string. More on Time Domain character string in appendix 5. There may also be vehicle segments attached to the manoeuvre that define the vehicle types affected by the manoeuvre.

Manoeuvre data is carriageway specific, not lane specific. There is manoeuvre between elements only if turning to another element is forbidden from all the lanes. Lane specific manoeuvre data is possible in Digiroad database, but the option is not in use.

Not all manoeuvres are indicated. Such are, for example, one-way road elements, pedestrian and cycle paths and blocked passages.

There may be vehicle allowed or not allowed data in the manoeuvre if the manoeuvre refers only to certain vehicle types. There is no manoeuvre if vehicle allowed or not allowed data is valid regardless of the direction of traffic because the vehicle type data without a manoeuvre attached to it is sufficient.

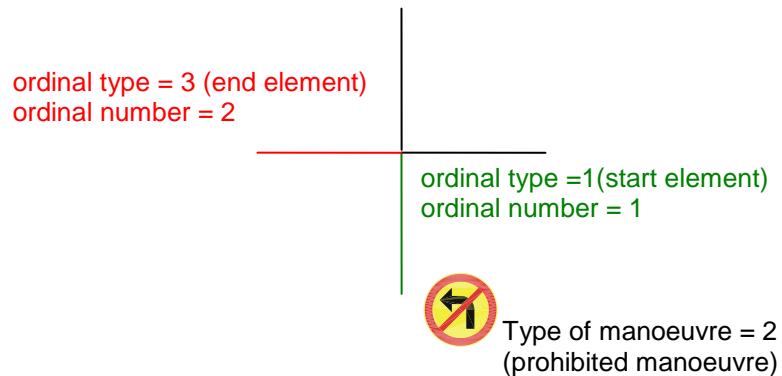

In the image the manoeuvre consists of two elements.

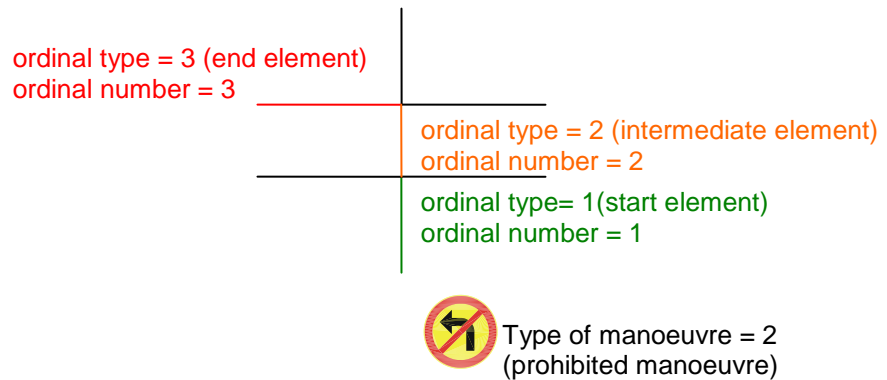

In the image the manoeuvre consists of three elements in the junction of a two-carriageway and single carriageway roads.

Types of manoeuvre are:

- 1 Compulsory manoeuvre
- 2 Prohibited manoeuvre
- 4 Physically restricted manoeuvre

There is a physical obstacle, e.g. pavement or traffic island between carriageways or lanes that has not been taken into account in the geometry. There may not be a need for a manoeuvre if the pavement or traffic island has been taken into account in the geometry because in that case the geometries are one-way and they already restrict the manoeuvre.

The values of manoeuvre element are:

- 1 Start element
The sequence number of beginning element of a road is 1.
- 2 Intermediate element
The sequence number of intermediate element is 2 - (n-1) if there are any intermediate elements of a road.
- 3 End element
The sequence number of end element of a road is 2 - n.

4.4 Other attribute data of road and street network

4.4.1 Speed restrictions

Table: DIGIROAD_SEGMENTTI

segment type 5 / dynamic attribute type 11

The value of speed limit (km/h) is in the field of dynamic attribute data. Speed restrictions are line segments.

4.4.2 Public transport stop

Tables: DIGIROAD_SEGMENTTI

DIGIROAD_NIMI

segment type 4

Stop is a point segment.

A stop has:

- a name (see [4.1.1](#))
- type of stop (1-7)
- maintainer identifier (if there is one)
- national identifier
- information on the shelter existence of the stop (1-3)

Values of stop type are:

- 1 Tram
- 2 Local buses
- 3 Long distance buses
- 4 Local and long distance buses
- 5 Long distance and express buses
- 6 Local, long distance and express buses
- 7 No data

Values of the shelter existence of stop are:

- 1 No
- 2 Yes
- 3 No data

4.4.3 Paved road

Table: DIGIROAD_SEGMENTTI

segment type 5 / dynamic attribute type 26

All pavement types are classified as pavements. There is no pavement segment on the part of road network covered with gravel. Paved road is a line segment.

4.4.4 Level crossing of a railway

Tables: DIGIROAD_SEGMENTTI

DIGIROAD_NIMI

segment type 5 / dynamic attribute type 25

The code value of safety device type is in the field of dynamic attribute value. Level crossing of a railway is a point segment.

Level crossing of a railway has:

- a name (see [4.1.1](#))
- type of safety device (1-5)

Values of level crossing of a railway safety device type are:

- 1 Railway not in use
- 2 No safety device
- 3 Only light and/or sound signal
- 4 Half barrier and possible light and/or sound signal
- 5 Full barrier and possible light and/or sound signal

4.4.5 Number of lanes

Table: DIGIROAD_SEGMENTTI

segment type 5 / dynamic attribute type 5

The data on number of lanes is given according to the direction when there is more than one lane in a particular direction. In other cases the presumption is that there is one lane in each direction of traffic flow (two directions: 1+1 lanes, one direction: 1 lane). Diverging lanes are not included. Number of lanes (>1) is in the field of dynamic attribute value. Number of lanes is a line segment.

4.4.6 Road address

Table: DIGIROAD_SEGMENTTI

segment type 2

To avoid the same numbers as in continental Finland, 10 000 has been added to road numbers of Åland. Road address is a line segment.

Road address has:

- a road number
- a number of the part of a road
- carriageway number

Values of carriageway numbers are:

- 1 First carriageway on the right in the direction of the road number
- 2 Second carriageway on the right in the direction of the road number
- 9 Single carriageway road

4.4.7 Bridge, underpass or tunnel

Tables: DIGIROAD_SEGMENTTI

DIGIROAD_NIMI

segment type 6

The type of bridge, underpass or tunnel is defined according to whether, when using the particular part of the road and street network, there is a bridge, underpass or tunnel. On one of the centre line geometries crossing each other on different levels there is an underpass and at the same point there is a bridge. Bridge, underpass or tunnel is a line segment.

Bridge, underpass or tunnel has:

- a name (see [4.1.1](#))
- type of bridge, underpass or tunnel (1-3)

Values of bridge, underpass or tunnel type are:

- 1 Bridge
- 2 Tunnel
- 3 Underpass

4.4.8 Intersection traffic light control or traffic light

Table: DIGIROAD_SEGMENTTI

In Digiroad: segment type 5 / dynamic attribute type 9

Intersection traffic light control is as point segment at the intersectional point of each reference chain of crossing geometries. A traffic light between intersections is shown as a point segment, e.g. at a pedestrian crossing controlled by a traffic light if there is no crossing geometry.

4.4.9 Width

Table: DIGIROAD_SEGMENTTI

segment type 5 / dynamic attribute type 8

Width of a road is the width of a road or street including the shoulders. Width value (cm) is in the field of dynamic attribute value. Width is a line segment.

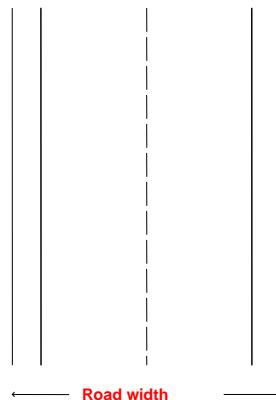

Width means the width of a road or street including the shoulders.

4.4.10 Built-up area

Table: DIGIROAD_SEGMENTTI
segment type 5 / dynamic attribute type 30

Built-up area is the part of the road and street network which is inside the area indicated by a sign for a built-up area. Built-up area is a line segment..

4.4.11 Road affected by thawing

Table: DIGIROAD_SEGMENTTI
segment type 5 / dynamic attribute type 6

Road affected by thawing is the part of the traffic network that tends to suffer from thawing. Road affected by thawing is a line segment.

4.4.12 Lit road

Table: DIGIROAD_SEGMENTTI
segment type 5 / dynamic attribute type 27

There is no lit road segment on the part of the road network that has no lighting. Lit road is a line segment.

4.4.13 Directional traffic sign and its information

Tables: DIGIROAD_SEGMENTTI
DIGIROAD_OPASTUSTAULUN_INFORMAATIO

In Digiroad: segment type 5 / dynamic attribute type 13

Directional traffic sign and its information are the signposts which are situated on or directing to motorways or semi-motorways. Typically directional sign is located at a junction or just before it. Of the signs directing to a particular junction, only one is included (the last or the most comprehensive one). There may be several

directions (pieces of information on a directional sign) on a directional traffic sign. Directional traffic sign is a point segment.



Image shows four directions, i.e. four pieces of information on a directional traffic sign in a directional traffic sign segment.

Directional traffic sign information contains the following data, separated by a semicolon:

PLACE NAMES;DISTANCE;ROADNUMBERS;E-ROAD NUMBERS;DIRECTION OF THE ARROW;COLOUR;LOCATION

Within the fields, the information is separated by a colon, for example:
 "HELSINKI:HELSINGFORS;100;4:9;E75;6;1;500;"

More detailed description of the parts of the character string:

Place names: Names of places written as in the directional traffic sign (all CAPITAL letters).

Distance: The distance to the place on the directional traffic sign in kilometres.

Direction of the arrow:

- 0 = no data
- 1 = left
- 2 = right
- 3 = ahead
- 5 = between left and ahead
- 6 = between right and ahead
- 7 = between backward and left
- 8 = between right and backward

Background colour:

- 0 = no data
- 1 = green (motorway or semi-motorway)
- 2 = blue (road)
- 3 = white (local, e.g. a town district)

Location: Distance of the directional traffic sign from the junction in metres.

4.4.14 Construction status

Table: DIGIROAD_SEGMENTTI
segment type 5 / dynamic attribute type 15

Construction status is the part of the road network which is under construction or planned to be constructed. Code value of the construction status is in the field of dynamic attribute value. Construction status is a line segment.

Values of construction status are:

- 1 Under construction
- 2 Planned
- 3 Under construction, but open

4.4.15 Traffic volume

Table: DIGIROAD_SEGMENTTI
segment type 5 / dynamic attribute type 33

Value of traffic volume is in the field of dynamic attribute value. Traffic volume is the average number of vehicles passing per day. Traffic volume is a line segment.

It is also possible to include the following attribute data in Digiroad database:

4.4.16 Speed limit during winter

Tables: DIGIROAD_SEGMENTTI

4.4.17 Variable speed limit

Tables: DIGIROAD_SEGMENTTI

4.4.18 Owner

Tables: DIGIROAD_SEGMENTTI
Type of owner is municipality or road district.

4.4.19 Groundwater area

Table: DIGIROAD_SEGMENTTI

4.4.20 Pedestrian crossing

Table: DIGIROAD_SEGMENTTI

4.4.21 Overlapping tramline

Table: DIGIROAD_SEGMENTTI
Overlapping tramline is the part of road network where a tramline shares a lane with other vehicle traffic.

4.4.22 Restriction of passage

Table: DIGIROAD_SEGMENTTI

Restriction of passage is the part of traffic network where road works may impede traffic.

4.4.23 RDS/TMC location

Table: DIGIROAD_SEGMENTTI

RDS/TMC location has class and type data.

4.5 Other features

4.5.1 Service

Tables: DIGIROAD_PALVELU
 DIGIROAD_SEGMENTTI
 DIGIROAD_SEGMENTTI_PALVELU
 DIGIROAD_NIMI

segment type 7 (connection to service)

Service means the kind of service that helps and supports the users of traffic network, e.g. a parking building or bus station. Service has a geometry point which is connected to traffic network by defining a point segment in the traffic network where there is an exit from and/or entrance to a service.

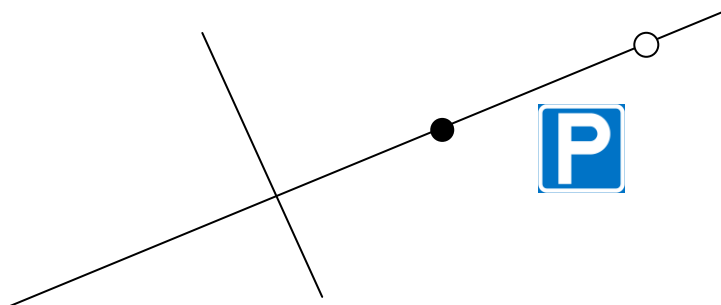

Image shows a parking sign (parking area type service) at the actual location of the parking area. Service connection segment of an entrance to a parking area is marked with a black dot and that of the exit with a white dot.

Service has:

- a name (see [4.1.1](#))
- type of service (1-17)
- type of rest area (on rest areas or lay-bys)
- service segment (1 - n)

Passage to service has:

- connection to service
- type of passage (1-3)

Types of service are:

- 1 Hospital/polyclinic
- 2 First aid post

- 3 Cargo centre
Cargo centre is for collecting and sorting of non-passenger goods (not luggage).
- 4 Customs
- 5 Frontier crossing
- 6 Rest area (or lay-by)
Types of rest area are:
 - 1 Rest area, with a wide range of facilities
Wider range of facilities offers other facilities and services in addition to the basic ones.
 - 2 Rest area, basic facilities
Basic facilities include the following facilities or services:
 - parking area
 - waste container
 - toilets
 - table and bench
 - 3 Private service area
Privately run service area has e.g. a petrol station, kiosk, cafeteria, restaurant or accommodation services.
- 7 City centre
City centre describes a central location of a municipality or built-up area. Typically it is the town hall, railway station or other central activity centre (i.e. church, market place or pedestrian district).
- 8 Airport
An airport which accommodates either cargo or passenger traffic of a commercial or private nature.
- 9 Ferry terminal
The access point or check-in area for a ferry company.
- 10 Taxi stand
- 11 Railway station
- 12 Parking area
Parking area which has at least 40–50 public parking spaces. There may be a charge for parking but there may not be other restrictions (e.g. parking only allowed for customers of a particular store).
- 13 Car shipping terminal
A location where cars may be loaded onto trains or ferries.
- 14 Coach and lorry parking
- 15 Parking building
Parking building which has at least 40–50 public parking spaces. There may be a charge for parking but there may not be other restrictions (e.g. parking only allowed for customers of a particular store).
- 16 Bus station

- 17 Landmark
Landmark is a noticeable building, monument, nature attraction etc. which helps navigation, e.g. Näsinneula observation tower or the tower of Helsinki Olympic Stadium.

Types of passage to service are:

- 1 entrance and exit
- 2 entrance
- 3 exit

4.5.2 Municipality

Table: DIGIROAD_KUNTA

Municipality data does not include location data. Municipality data can be connected to traffic elements according to the municipality number, which makes it possible to use the language or language relation data when handling or presenting names of traffic elements.

Municipality has:

- Municipality number
- Municipality language or language relation

Values of municipality language or language relation are:

- 10 fin only Finnish
- 12 fin mainly Finnish
- 20 swe only Swedish
- 21 swe mainly Swedish

It is also possible to include the following attribute data in Digiroad database:

4.5.3 Enclosed traffic area

Table: DIGIROAD_LIITANNAISLIKENNEALUE

Enclosed traffic area is any area type feature inside which unplanned traffic is allowed. Enclosed traffic areas are not part of traffic network and they have no overlapping road elements. Some enclosed traffic areas may include a service feature point, e.g. parking area.

4.5.4 Junction

Tables: DIGIROAD_RISTEYS

DIGIROAD_RISTEYS_LIIKENNE_ELEMENTTI

DIGIROAD_NIMI

Junction is a numbered motorway junction consisting of traffic elements.

4.5.5 Specific combination of roads or routes

Tables: DIGIROAD_VAYLA

DIGIROAD_VAYLA_LIIKENNEELEMENTTI

Specific combination of roads and routes is a group of traffic elements joined together by an activity or marker, e.g. routes for dangerous deliveries, historic roads or scenic roads.

4.5.6 Train or ferry connection

Tables: DIGIROAD_LIIKENNEYHTEYS

Train or ferry connection is the part of traffic network which can be used for transporting cars using e.g. ferries or trains. Train or ferry connection consists of ferry or railway elements and describes one whole connection, e.g. car ferry from Turku to Mariehamn or autorack from Helsinki to Rovaniemi.

4.5.7 Grade separated point

Table: DIGIROAD_ERITASORISTEYS

Grade separated point is a geometry point where crossings of traffic elements occur with the help of bridges, underpasses or tunnels. Grade separated points always consist of two levels, i.e. reference to a traffic element going over or under.

4.5.8 Town district

Tables: DIGIROAD_KAUPUNGINOSA tai DIGIROAD_PALVELU

5 APPENDIX

- Appendix 1: Data objects of the database
- Appendix 2: Adjustments on data objects
- Appendix 3: Files, fields and descriptions
- Appendix 4: Codes
- Appendix 5: Time Domain character string
- Appendix 6: Description of Digiroad K delivery format
- Appendix 7: Description of Digiroad XML R delivery format
- Appendix 8: Class chart of Digiroad XML R delivery format

APPENDIX 1: DATA OBJECTS OF THE DATABASE

This table shows the data objects of Digiroad database. The data objects included in material deliveries are described in Digiroad Quality description document.

17.9.2007	Data objects for functional classes	1 - 4	5	6	10	Others
Attribute data of road element	Direction of traffic flow	x	x	x	x	
	Name	x	x	x	x	
	Address numbers	x	x	x	x	
	Route type	x	x	x	x	
	Functional class	x	x	x	x	
	Type of road element	x	x	x	x	
	Municipality number	x	x	x	x	
	National road class	x				
	E-road number	x				
	Type of railway element					x
	Type of ferry element					x
	Travel time					x
	Restriction of use of road element	x	x			
	Opening Period	x	x			
	Traffic jam sensitivity of road element	x				
	Measured length of road element	x	x			
	Scenic value of road element	x	x			
Restrictions of passage on the road and street network	Blocked passage	x	x	x	x	
	Traffic barrier gate which can be opened	x	x		x	
	Vehicle allowed	x	x			
	Vehicle not allowed	x	x			
	Maximum allowed ... x 7	x	x			
	Manoeuvre	x	x			
Other attribute data of road and street network	Speed restriction	x	x			
	Speed limit during winter	x				
	Variable speed limit	x				
	Public transport stop	x	x			
	Paved road	x	x	x	x	
	Level crossing of a railway	x	x			
	Number of lanes	x				
	Road address	x				
	Bridge, underpass or tunnel	x	x			
	Intersection traffic light control or traffic light	x	x			
	Width	x	x	x		
	Built-up area	x	x			
	Road affected by thawing	x	x			
	Lit road	x	x			
	Directional traffic sign	x				
	Construction status	x				
	Traffic volume	x				
	Owner	x	x			
	Groundwater area	x	x			
	Pedestrian crossing	x	x			
	Overlapping tramline	x	x			
	Restriction of passage (road work)	x				
	RDS/TMC location	x	x			
Other features	Service					x
	Enclosed traffic area					x
	Junction					x
	Specific combination of roads and routes					x
	Train or ferry connection					x
	Grade separated point					x
	Town district					x

APPENDIX 2: ELABORATION OF DATA OBJECTS

17.9.2007 Data objects X=> compulsory, x=> possible for data object, but not compulsory

		name	validity direction	validity lane	validity period	point	line	area	connection
Attribute data of road element	Direction of traffic flow	X							
	Name	x							
	Address numbers	x							
	Route type	X							
	Functional class	X							
	Type of road element	x							
	Municipality number	X							
	National road class	x							
	E-road number	x							
	Type of railway element	x							
	Type of ferry element	x							
	Travel time	x							
	Restriction of use of road element	x							
	Opening Period	x							
	Traffic jam sensitivity of road element	x							
Measured length of road element	x								
Scenic value of road element	x								
		name	validity direction	validity lane	validity period	point	line	area	connection
Restrictions of passage on the road and street network	Blocked passage		X			X			
	Traffic barrier gate which can be opened		X			X			
	Vehicle allowed		X	x	x		X		
	Vehicle not allowed		X	x	x		X		
	Maximum allowed ... x 7		X				X		
	Manoeuvre			x	x				X
Other attribute data of road and street network	Speed restriction		X	x			X		
	Speed limit during winter		X	x			X		
	Variable speed limit		X	x			X		
	Public transport stop	x	X			X			
	Paved road		X				X		
	Level crossing of a railway	x	X			X			
	Number of lanes		X		x		X		
	Road address		X				X		
	Bridge, underpass or tunnel	x	X				X		
	Intersection traffic light control or traffic light		X				X		
	Width		X				X		
	Built-up area		X				X		
	Road affected by thawing		X				X		
	Lit road		X				X		
	Directional traffic sign		X				X		
	Construction status		X				X		
	Traffic volume		X		x		X		
	Owner		X				X		
	Groundwater area	x	X				X		
	Pedestrian crossing		X				X		
	Overlapping tramline		X	x			X		
	Restriction of passage (road work)		X	x	x		X		
	RDS/TMC location		X				X	X	
Other features	Service	x				X			
	Municipality								X
	Enclosed traffic area							X	
	Junction	x							X
	Specific combination of roads and routes								X
	Train or ferry connection								X
	Grade separated point	x					X		
Town district									

APPENDIX 3: FILES, FIELDS AND DESCRIPTIONS

Main files of Digiroad R and K delivery formats and their fields and descriptions			3.7.2007
File	Field	Description (the ones in internal use are not included)	Unit
DIGIROAD_LIIKENNE_ELEMENTTI			
	VAYLATYYPP	Route type	
	TOIMINNALL	Functional class	
	EUROOPPATI	E-road number	
	KANSALLINE	National road class of road element	
	TYYPPI	Type of road element	
	KAYTTORAJO	Restriction of use of road element	
	LIIKENNEVI	Direction of traffic flow in relation to direction of digitisation	
	KAYTTOAIKA	Opening Period as Time Domain character string	
	RUUHKAUTUM	Traffic jam sensitivity of road element	
	ENS_TALO_O	First house on the right in the direction of digitisation	
	TALONUMERO	House numbering structure of road element	
	ENS_TALO_V	First house on the left in the direction of digitisation	
	MITATTU_PI	Measured length of road element	cm
	MAISEMALLI	Scenic value of road element	
	VIIM_TALO_	Last house on the right in the direction of digitisation	
	VIIM_TAL1	Last house on the left in the direction of digitisation	
	LAUT_TYYPPI	Type of ferry	
	RAUTAT_ELE	Type of railway	
	MATKA_AIKA	Travel time of railway or ferry element	
	INV_PAALU_	Start point on reference chain	ratio
	INV_PAAL_1	End point on reference chain	ratio
	LIIKYHTEYS	OID_TUNNUS of the file DIGIROAD_LIIKENNEYHTEYS	
	LIITALUE_O	OID_TUNNUS of the file DIGIROAD_LIITANNAISLIIKENNEALUE	
	KETJU_OID	OID_TUNNUS of the file DIGIROAD_KETJU	
	GUID / VIITE_GUID	Digiroad ID, R: GUID K: VIITE_GUID	
	TIEE_KUNTA	Municipality number of most of traffic element	
	OID_TUNNUS / VIITE_OID	OID identifier for file connections, R: OID_TUNNUS K: VIITE_OID	
DIGIROAD_NIMI			
	NIMI_LAJI	Type of name	
	KIELIKOODI	Language code of name	
	TEKSTI	Name text	
	VIITE_TAU	Table the name refers to	
	VIITE_OBJE	OID_TUNNUS or VIITE_OID the name refers to	
	LIIKENNE_E	OID_TUNNUS or VIITE_OID of the file LIIKENNE_ELEMENTTI	
	SEGMENTTI	OID_TUNNUS or VIITE_OID of the file DIGIROAD_SEGMENTTI	
	OID_TUNNUS	OID identifier	
DIGIROAD_KETJU			
	TUNNUS	OID identifier for file connections	
	GUID	Digiroad ID	
	OID_TUNNUS	OID identifier for file connections	

DIGIROAD_SEGMENTTI		
TYYPPI	Segment type	
LOPPUPISTE	End point of segment on reference chain	ratio
ALKUPISTE	Start point of segment on reference chain	
VAIKUTUSKA	Validity lane of segment on the right in the validity direction	
VAIKUTUSSU	Validity direction of segment in relation to: R: reference chain, K: segment	
VAIKUTUSAI	Validity period of segment as Time Domain character string	
TIEOSANUME	Road address segments' number of part of road	
TIENUMERO	Road number of road address segments	
DYN_ARVO	Value of dynamic attribute	
DYN_TYYPPI	Type of dynamic attribute	
PYSAKKI_VA	National identifier of stop	
PYSAKKI_TY	Type of stop	
PYSAKKI_SU	Direction of stop	
PYSAKKI_KA	Shelter of stop	
PYSAKKI_YL	Maintainer identifier of stop	
PALVELU_PA	Type of passage to service	
SILTATAITU	Type of bridge or tunnel	
PALVELU_OB	OID_TUNNUS of the file DIGIROAD_PALVELU	
KETJU_OID	OID_TUNNUS of the file DIGIROAD_KETJU	
AJORATANUM	Lane number of road address segments	
GUID / VIITE_GUID	Digiroad ID, R: GUID K: VIITE_GUID	
OID_TUNNUS / VIITE_OID	OID identifier for file connections, R: OID_TUNNUS K: VIITE_OID	
DIGIROAD_KAANTYMISMAARAYS		
TYYPPI	Type of manoeuvre	
VAIKUTUSAI	Validity period of manoeuvre as Time Domain character string	
GUID	Digiroad ID	
OID_TUNNUS	OID identifier for file connections	
DIGIROAD_KAANTYMISMAARAYS_ELEMENTTI		
ELEMENT_OB	OID_TUNNUS or VIITE_OID of the file DIGIROAD_LIIKENNE_ELEMENTTI	
KAANTMAAR_		
KAISTANRO	Validity lane of manoeuvre on the right in the validity direction	
ELEM_JARJE	Ordinal number of road element in manoeuvre	
ELEM_JARJ_1	Ordinal type of manoeuvre element	
OID_TUNNUS	OID identifier	
DIGIROAD_SEGMENTTI_KAANTYMISMAARAYS		
SEGMENTTI_		
KAANTMAAR_		
OID_TUNNUS	OID identifier	
DIGIROAD_PALVELU		
TYYPPI	Types of service	
LISATieto	Additional information on service	
RAUTATIEAS	Type of railway station	
PAIKKOJEN	Number of parking spaces	
LEPOALUE_T	Type of rest area	
GUID	Digiroad ID	
OID_TUNNUS		
DIGIROAD_SEGMENTTI_PALVELU		
PALVELU_OB	OID_TUNNUS of the file DIGIROAD_PALVELU	
SEGMENTTI_	OID_TUNNUS or VIITE_OID of the file DIGIROAD_SEGMENTTI	
OID_TUNNUS	OID identifier	
DIGIROAD_OPASTUSTAULUN_INFORMAATIO		
TEKSTI	Text of one line on a directional sign	
ELEMENT_OB	OID_TUNNUS or VIITE_OID of the file DIGIROAD_LIIKENNE_ELEMENTTI	
SEGMENTTI_	OID_TUNNUS or VIITE_OID of the file DIGIROAD_SEGMENTTI	
GUID	Digiroad ID	
OID_TUNNUS	OID identifier for file connections	
DIGIROAD_KUNTA		
KUNT_KOODI	Municipality number	
KUNT_VIRAL	Language or language relation of municipality	
GUID	Digiroad ID	
OID_TUNNUS		

APPENDIX 4: CODES

Main code values in Digiroad and their descriptions			7.4.2007		
File	Field	Description	Value	Description of value	Unit
DIGIROAD_LIIKENNE_ELEMENTTI					
	VAYLATYYPPI	Route type	1	Road	
			2	Street	
			3	Private road	
			4	Cycle or pedestrian path	
			5	Railway	
			6	Ferry	
	TOIMINNALL	Functional class	1	1: Regional main street / Class I main road	
			2	2: Regional main street / Class II main road	
			3	3: Local main street / Regional road	
			4	4: Collector street / Connecting road	
			5	5: Feeder street / Class I private road	
			6	6: Class II private road	
			10	10: Cycle or pedestrian path	
	TYYPPI	Type of road element	1	Part of a motorway	
			2	Part of a multiple carriageway which is not a motorway	
			3	Part of single carriageway	
			4	Part of a roundabout	
			6	Part of a roundabout	
			8	Slip road	
			10	Part of a service or emergency road	
			13	Part of a pedestrian zone (e.g. a pedestrian street)	
			14	Part of a cycle path	
			17	Part of a semi-motorway	
	LIIKENNEVI	Direction of traffic flow	2	Traffic is permitted in both directions	
			3	Traffic is permitted against the direction of digitisation	
			4	Traffic is permitted in the direction of digitisation	
			5	Traffic is closed in both directions	
	TALONUMERO	Structure of house numbering	2	Regular, even and uneven numbers on different sides	
			3	Regular, even and uneven numbers on the same side	
			4	No regularity	
	LAUT_TYYPPI	Type of ferry	1	Ferry	
			2	Cable ferry	
DIGIROAD_NIMI					
	NIMI_LAJI	Type of name	1	Official	
			2	Alternate	
	KIELIKOODI	Language code of name	1	fin Finnish	
			2	swe Swedish	
DIGIROAD_SEGMENTTI					
	VAIKUTUSSU	Validity direction of segment	1	Both directions	
			2	In the direction of digitisation	
			3	Against the direction of digitisation	
	TYYPPI	Type of segment	2	Road address	
			4	Stop	
			5	Dynamic attribute	
			6	Bridge, underpass or tunnel	
			7	Entrance to / exit from a service	
			8	Groundwater area	
	DYN_TYYPPI	Type of dynamic attribute	1	Vehicle allowed	
			3	Traffic barrier gate which can be opened	
			5	Number of lanes	
			6	Road affected by thawing	
			8	Width	cm

			9	Intersection traffic light control or traffic light	
			11	Speed restriction	km/h
			13	Directional traffic sign	
			14	Overlapping tramline	
			15	Construction status	
			16	Blocked passage	
			17	Pedestrian crossing	
			18	Maximum height allowed for a vehicle	cm
			19	Maximum length allowed for a vehicle or articulated vehicle	cm
			20	Maximum total mass allowed for an articulated vehicle	kg
			21	Maximum weight per axle allowed for a vehicle	kg
			22	Maximum total weight allowed for a vehicle	kg
			23	Maximum width allowed for a vehicle	cm
			24	Maximum weight per tandem-axle allowed for a vehicle	kg
			25	Level crossing of a railway	
			26	Paved road	
			27	Lit road	
			29	Vehicle not allowed	
			30	Built-up area	
			31	Speed limit during winter	
			32	Variable speed limit	
			33	Traffic volume	
DYN_ARVO	Dynamic attribute Vehicle type	(values are type specific)	1	All vehicles	
			2	Motor vehicle	
			3	Vehicle	
			4	Truck	
			5	Bus	
			6	Van	
			7	Passenger car	
			8	Taxi	
			9	Motorcycle	
			10	Moped	
			11	Cycle	
			12	Pedestrian	
			13	Articulated vehicle	
			14	Tractor or farm vehicle	
			15	Car with trailer / recreational vehicle	
			16	Delivery vehicle	
			17	Emergency vehicle	
			18	Carpool (HOV) vehicle	
			19	Military vehicle	
			20	Vehicle with dangerous load	
			21	Driving in service purposes	
			22	Driving to the lots	
			23	Driving through	
DYN_ARVO	Dynamic attribute Level crossing	(values are type specific)	1	Railway not in use	
			2	No safety device	
			3	Only light and/or sound signal	
			4	Half barrier and possible light and/or sound signal	
			5	Full barrier and possible light and/or sound signal	
DYN_ARVO	Dynamic attribute Construction status	(values are type specific)	1	Under construction	
			2	Planned	
			3	Under construction, but open	
PYSAKKI_TY	Type of stop		1	Tram	
			2	Local buses	

			3	Long distance buses	
			4	Local and long distance buses	
			5	Long distance and express buses	
			6	Local, long distance and express buses	
			7	No data	
	PYSAKKI_SU	Direction of stop	1	In the direction of digitisation	
			2	Against the direction of digitisation	
	PYSAKKI_KA	Shelter existence of stop	1	No	
			2	Yes	
			3	No data	
	SILTATAITU	Type of bridge, underpass or tunnel	1	Bridge	
			2	Tunnel	
			3	Underpass	
	PALVELU_PA	Type of entrance to / exit from a serv	1	Entrance and exit	
			2	Entrance	
			3	Exit	
DIGIROAD_KAANTYMISMAARAYS					
	TYYPPI	Type of manoeuvre	1	Compulsory manoeuvre	
			2	Prohibited manoeuvre	
			4	Physically restricted manoeuvre	
DIGIROAD_KAANTYMISMAARAYS_ELEMENTTI					
	ELEM_JAR_1	Value of manoeuvre element	1	Start element	
			2	Intermediate element	
			3	End element	
DIGIROAD_PALVELU					
	TYYPPI	Type of service	1	Hospital/polyclinic	
			2	First aid post	
			3	Cargo centre	
			4	Customs	
			5	Frontier crossing	
			6	Rest area (or lay-by)	
			7	City centre	
			8	Airport	
			9	Ferry terminal	
			10	Taxi stand	
			11	Railway station	
			12	Parking area	
			13	Car shipping terminal	
			14	Coach and lorry parking	
			15	Parking building	
			16	Bus station	
			17	Landmark	
	LEPOALUE_T	Type of rest area	1	Rest area with a wide range of facilities	
			2	Rest area, basic facilities	
			3	Private service area	
	RAUTATIEAS	Type of railway station	1	Important railway station	
			2	Less important railway station	
			3	Underground/metro station	
DIGIROAD_KUNTA					
	KUNT_VIRAL	Language or language relation of municipality	10	fin only Finnish	
			12	fin mainly Finnish	
			20	swe only Swedish	
			21	swe mainly Swedish	

APPENDIX 5: TIME DOMAIN CHARACTER STRING

General

Time Domain is defined in GDF and it is a way to indicate precise and complex validity periods for various features and attributes. Notation consists of starting time of the validity period and duration of the validity in the following way: [(starting time){duration}].

For example, [(M5d1){d1}] means:

- Starting time: any year in the fifth month on the 1st day at 00:00:00
- Duration: one day (i.e. 24 hours or 1440 minutes)

Starting time

Notations of Time Domain starting time

unit of time	compared time	code	values (n,x)	comment
year		ynnnn	0...9999	
month	of year	Mnn	1...12	
week	of year	wnn	1...53	
day	of month	dnn	1...28/29/30/31	maximum depends on month
day	of week	tn	1...7	from Sunday to Saturday
day of week	week of month	fxn	x: 1...5	week from beginning of month
				from where validity begins
	day of week		n: 1...7	from Sunday to Saturday
day of week	week of month	lxn	x: 1...5	week from end of month
				from where validity begins
	day of week		n: 1...7	from Sunday to Saturday
hour	of day	hnn	0...23	
minute	of hour	mnn	0...59	
second	of minute	snn	0...59	

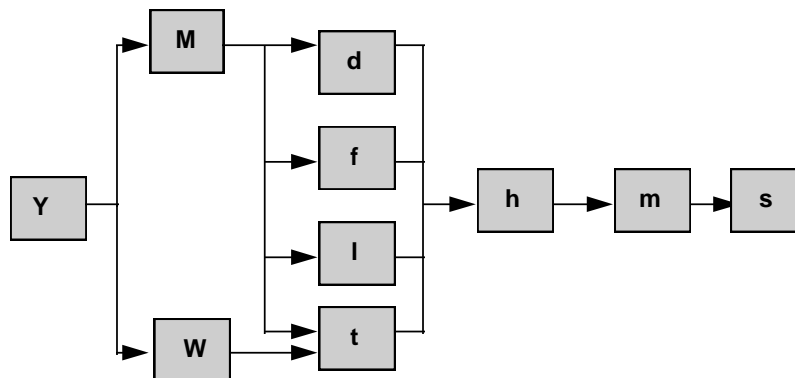

Possible combinations of starting times codes.

Codes are listed from the longest period to the shortest one (y...s). If there is no unit of time marked in the beginning, all values are valid. If there is no unit of time marked in the middle or at the end, the value of the unit is its presumption value, i.e. the smallest possible unit (e.g. M1, w1, d1, h0, m0, s0).

Examples of the notations of starting times:

(y2001) 1.1.2001, 00:00:00
 (M5) every year, 1.5. 00:00:00
 (w12) every year, Sunday on the 12th week, 00:00:00
 (d14) every year, 14th of every month 00:00:00
 (t2) every year, Monday of every week 00:00:00
 (f23) every year, Tuesday of the second week of every month 00:00:00
 (l12) every year, Monday of the last week of every month 00:00:00
 (h6) every year, every day of every month 06:00:00
 (m30) every year, every day of every month, every hour 30:00
 (s15) every year, every day of every month, every hour, every minute :15
 (w9h11m30) every year, every day of the 9th week 11:30:00
 (M4m30) every year, every day of every April, every hour 30:00

Correspondingly:

14th November 2001 (00:00:00)	(y2001M11d14)
every year 2.5. 17:31:00	(M5d2h17m31)
every year, last Sunday of February	(M2l11)

Duration

Duration is the total time of Time Domain notations of time units, e.g. {y2M2w1d2}, which means the validity from starting time onwards, for two years + two months + one week + two days.

A minus sign can be added in front of the duration, e.g. {-d5}, which means the validity on the preceding five days.

Notations of Time Domain duration

Unit of time	Code	Values (n)	Correspondence	Comments
year	ynn	0...99		Duration ends on the last day of the month if there is no such day in the year when duration ends, e.g. [(y2000M2d29){y2}).
month	Mnn	1...99	{M12}={y1}	Duration ends on the last day of the month if there is no such day in the month when duration ends, e.g. [(y2001M1d31){M1}).
week	wnn	1...99		
day	dnn	1...99	{d7}={w1}	
hour	hnn	0...99	{h24}={d1}	
minute	mnn	0...99	{m60}={h1}	
second	snn	0...99	{s60}={m1}	

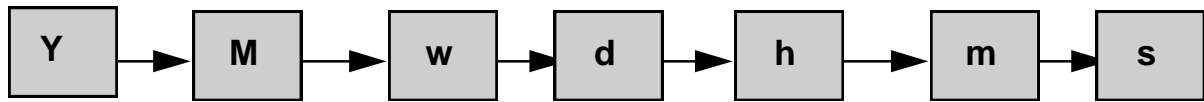

Possible combinations of duration.

Time Domain combinations

There are combination options defined in the Time Domain notations that make it possible to indicate more complex durations. The following options are in use:

- A+B: property is valid in both cases (OR)
- A*B: property is valid when both are valid (AND)
- A-B: property is valid when only A is valid (A AND NOT B)

With combinations the same result can be achieved in several different ways, because e.g. $A*(B+C) = (A*B)+(A*C)$.

Examples

- Every day from 9 a.m. to 1 p.m.
[(h9){h4}]
- Every Friday in March from 7.30 p.m. to 10 p.m.
[(M3t6h19m30){h2m30}]
- The last 15 minutes of the year 2001 (15 minutes before the year 2002)
[(y2002){-m15}]
- Every day from Monday to Saturday between 9 a.m. and 12 noon and between 1.30 and 7 p.m., except on the last Tuesday in January, 1st of May and in August

[[[[[(h9){h3}]+[(h13m30){h5m30}]]*(t2){d6}]]-[(M11t3){d1}]-[(M5){d1}]-[(M8){M1}]]

APPENDIX 6: DESCRIPTION OF DIGIROAD K DELIVERY FORMAT

General

Digiroad K is a delivery format in which traffic elements are disconnected into homogenous parts according to their attribute data. Dynamically segmented attribute data, i.e. segments have been disconnected in the same way as traffic elements. In Digiroad K delivery format the attribute data in DIGIROAD_SEGMENTTI table do not need to be located dynamically with the help of reference chains because disconnected segments have their own geometry. In Digiroad K delivery format the disconnected attribute data in DIGIROAD_SEGMENTTI table can be connected with disconnected traffic elements in DIGIROAD_LIIKENNE_ELEMENTTI table. This delivery format is suitable for the use with e.g. MapInfo (version 7.0 or newer). Digiroad K is delivered in ESRI shape format.

Digiroad R and Digiroad K delivery formats are similar except for two files. In Digiroad R delivery format the segments and traffic elements have been extracted directly into the files. In Digiroad K each traffic element is checked in case there are segments attached to it and after that they are extracted in one of the following ways.

Processing traffic elements when there are line segments

If there are segments attached to reference chains at a traffic element, the traffic element is disconnected based on the beginning and end points of the line segments and geometry data is created to the segments (images 1 and 3). If there is no segment at a traffic element or if the segment equals the traffic element in length, it is extracted directly to Digiroad K delivery format.

In the same way the Digiroad K export process checks the segments. If a segment is longer than a traffic element, the procedure disconnects the segment based on the beginning and end points of the traffic elements linked with it and geometry data is created to the new, disconnected segments based on the end points of traffic elements (image 2). If, instead, the segments are on top of each other, the procedure disconnects the overlapping segments in a way that at the traffic element that is to be disconnected there are segments of the same length as the disconnected traffic elements (image 3).

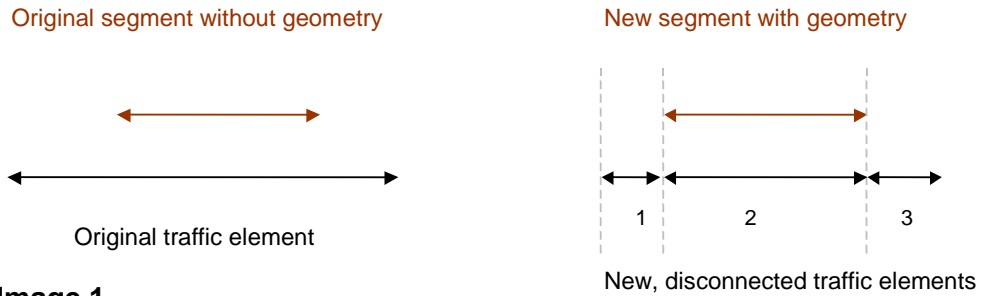

Image 1

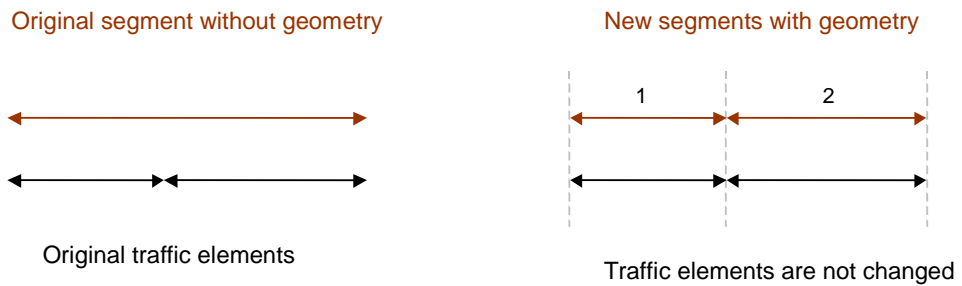

Image 2

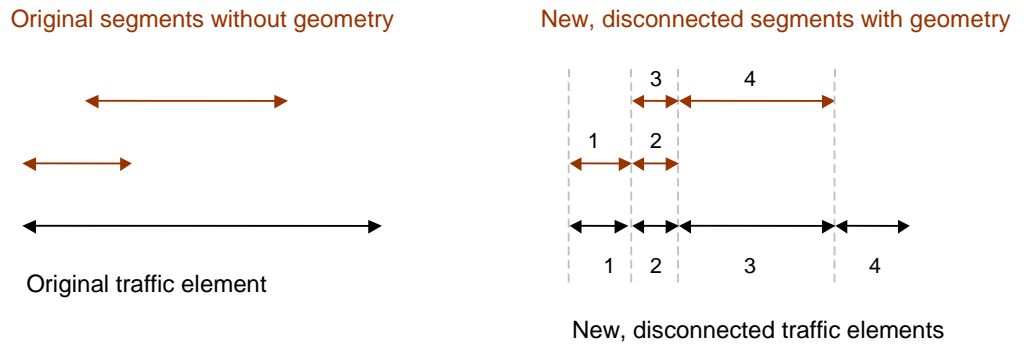

Image 3

Processing traffic elements when there are point segments

When segments are point segments, the processing of traffic elements is as follows:

If a segment is at the beginning of a traffic element, it should be checked which direction the pole values increase and then the traffic element is disconnected after one unit of measure from the segment, in the direction of the increase. For example, if $TIEE_INV_PAALU_ALKU < TIEE_INV_PAALU_LOPPU$, traffic element is disconnected at $SEGM_ALKUPISTE + 1$, for example 1201 or if

$TIEE_INV_PAALU_ALKU > TIEE_INV_PAALU_LOPPU$, traffic element is disconnected at $SEGM_ALKUPISTE - 1$, for example 1799.

If a segment is at the end of a traffic element, it should be checked which direction the pole values increase and then the traffic element is disconnected after one unit of measure from the segment, against the direction of the increase. For example, if $TIEE_INV_PAALU_ALKU < TIEE_INV_PAALU_LOPPU$, traffic element is disconnected at $SEGM_LOPPUPISTE - 1$, for example 1499 or if $TIEE_INV_PAALU_ALKU > TIEE_INV_PAALU_LOPPU$, traffic element is disconnected at $SEGM_LOPPUPISTE + 1$, for example 1601.

If a segment is in the middle of a traffic element, processing is as for the previous ones. In the examples traffic elements are disconnected at 1350 and 1351 or at 1645 and 1646.

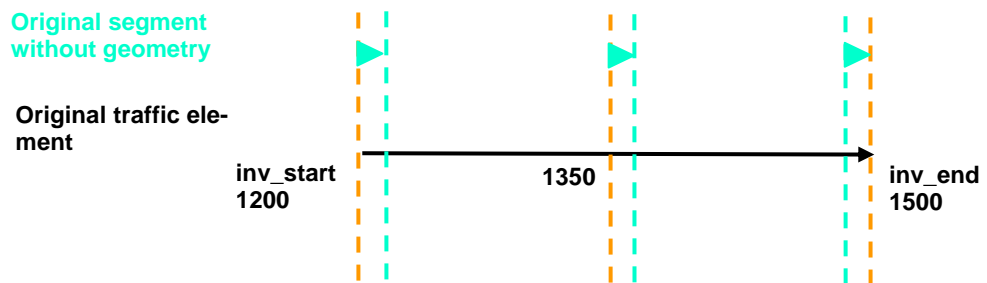

Image 4

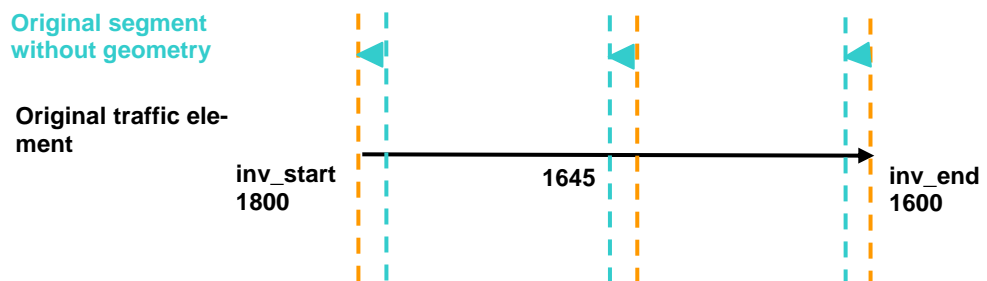

Image 5

Internal structure of Digiroad K files

Digiroad K export process goes through features that have been picked and stores them according to their feature classes into their own Shape files (e.g. DIGIROAD_SEGMENTTI, DIGIROAD_LIIKENNE_ELEMENTTI)

Digiroad internal identifier OBJECTID is stored during the Digiroad R export process into column OID_TUNNUS (applies to all tables) and during the Digiroad K export process in VIITE_OID column (applies only to segment and traffic element tables, for other tables OID is stored similarly to the export process of Digi-

road R). VIITE_OID is the identifier data of the original feature that has not been disconnected.

Digiroad external identifier GUID is stored during the Digiroad R export process in GUID column (applies to all tables) and during the Digiroad K export process in VIITE_GUID column (applies only to segment and traffic element tables, for other tables GUID is stored similarly to the export process of Digiroad R).

In the YKJ coordinate conversion of Digiroad K and R export processes conversion tool offered by the National Land Survey of Finland is used. The tool is based on the Public Administration recommendation JHS 154 (2.12.2003).

Processing Digiroad K files in MapInfo

Digiroad K files can be converted into MapInfo's own format with Universal Translator which can be accessed via Tools in MapInfo. If the Universal Translator cannot be accessed via Tools, select Tools – Tool Manager and activate Universal Translator there.

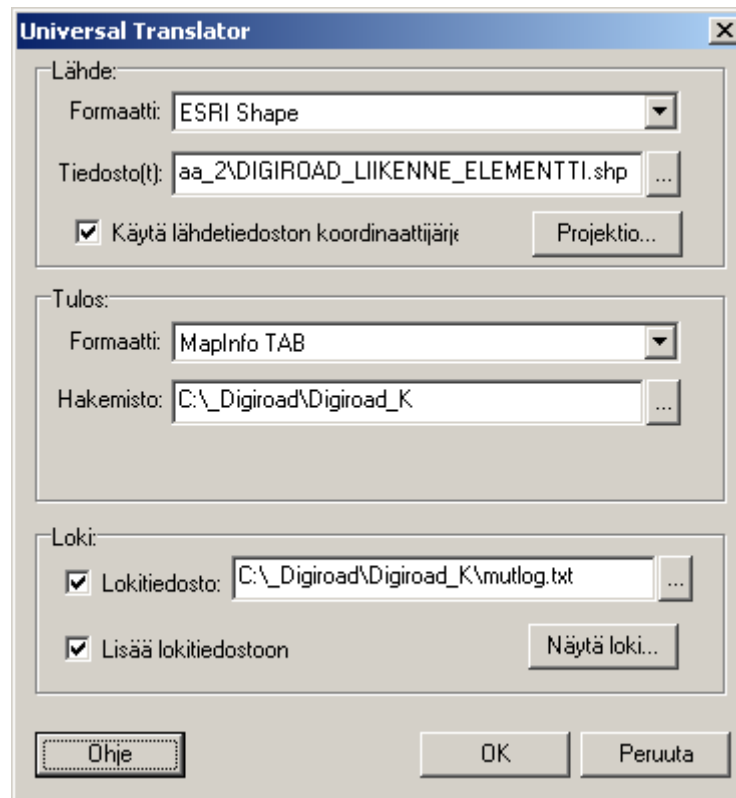

- Lähde (Source):
 - Formaatti (Format): ESRI Shape
 - Tiedosto(t) (Files): shp files created by the Digiroad K export process.
 - Käytä lähdetiedoston koordinaattijärjestelmää (Use projection setting in source file) (it is advised to carry out the coordinate and projection conversions later)
- Tulos (Destination)
 - Formaatti (Format): MapInfo TAB
 - Hakemisto (Directory): Directory where the converted file is stored
- Loki (Log)
 - Lokitiedosto (Log to File): Directory where the log of the conversion is created
 - Lisää lokitiedostoon (Append to Log): Select this if you do not want a separate file of each conversion

When the conversion has succeeded, there is a notice of it. As a result there are four files:

*.dat *.id *.map *.tab

Defining YKJ in Mapinfo

Coordinate and projection conversion in Universal Translator is not always successful with all the files. It is advised to carry out the coordinate and projection conversions after the Shape files have been converted to Tab files. Tab files are stored (File – Save Copy As) and YKJ (KKJ3) settings are chosen (File – Save Copy As – Projection).

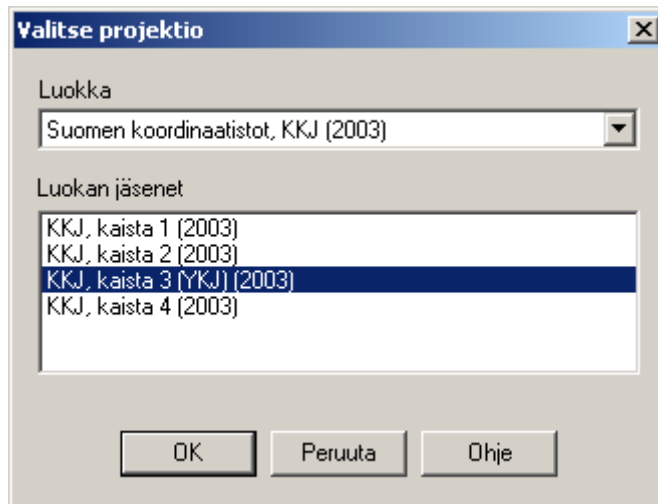

If the coordinate system is defined together with the conversion from Shape to Tab (Projektio, Projection), data may be broken (lines turn into squares).

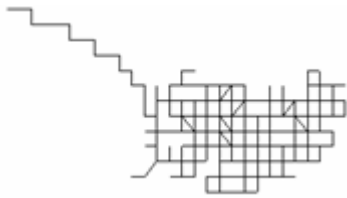

Connecting traffic elements and segments in Digiroad K delivery format

Segments and traffic elements are linked together with the help of geometry. Open the files converted in MapInfo (DIGIROAD_LIIKENNE_ELEMENTTI.tab and DIGIROAD_SEGMENTTI.tab) and select in the MapInfo main menu Kysely (Query) => SQL-kysely (SQL Select)

- Valitse kentät (Select Columns): Asterisk as a presumption: all columns
- tietokannoista (from Tables): Select from the menu:
 - DIGIROAD_LIIKENNE_ELEMENTTI
 - DIGIROAD_SEGMENTTI
- jotka täyttävät ehdot (where Condition)
 - Select from operator menu: "Contains Entire"
- Tietokantaan (into Table Named): Selection

Store the result (e.g. as ELEMENTIT_JA_SEGMENTIT) and open the chosen database.

As a result, in the ELEMENTIT_JA_SEGMENTIT database all segments are connected with all the traffic elements that have segments. The traffic elements that have no segments (pedestrian or cycle paths) in their segment database can be included in the result by doing the following:

Conduct an invert selection to the result of the previous query (Query1)

- Kysely (Query) => Käänteinen valinta (Invert selection)

Store the result (Selection) (e.g. as LISÄ_ELEMENTIT) and open the stored database.

Attach the database LISÄ_ELEMENTIT to the database ELEMENTIT_JA_SEGMENTIT

- Tietokanta => Liitä jatkeeksi

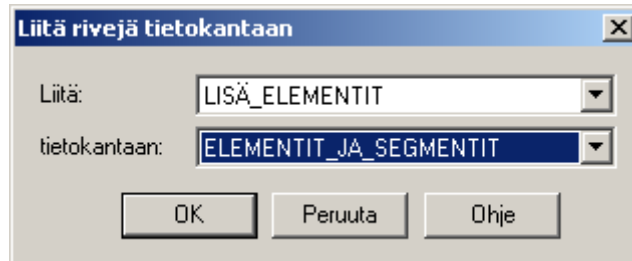

- Liitä (Append table): LISÄ_ELEMENTIT
- tietokantaan (To table): ELEMENTIT_JA_SEGMENTIT

Store ELEMENTIT_JA_SEGMENTIT database to which LISÄ_ELEMENTIT has been added.

APPENDIX 7: DESCRIPTION OF DIGIROAD XML R DELIVERY FORMAT

General

Digiroad XML R delivery format includes attribute data dynamically segmented on reference chains.

Digiroad XML R schema is based on the definitions of the version 1.0 of XML (<http://www.w3.org/TR/REC-xml/>). As basis for defining geometries has been the version 2.0 of GML (<http://www.opengis.org/docs/01-029.pdf>). Schema according to GML 2.0 (<http://schemas.opengis.net/gml/2.0.0/>).

Digiroad schema is the description of the structure of the Digiroad data including the interdependencies and hierarchies between Digiroad features.

Structure of Digiroad schema

Structure of message consists of

- A. A header which contains the needed data and links connected to the versions used in the message, namespaces and possibly other schemata that have a connection to the schema being handled. In Digiroad e.g. xlinks and feature schemata are used.
- B. The actual message body inside a root element.

a

```
<?xml version="1.0" encoding="UTF-8"?>
<!-- edited with XMLSPY v5 rel. 4 U (http://www.xmlspy.com) by Jussi Tokola (TietoEnator Oyj, Public & Healthcare) -->
<dr:Digiroad xmlns:dr="urn:schemas-tiehallinto-fi:digiroad:2003-10" xmlns:gml="http://www.opengis.net/gml"
xmlns:xlink="http://www.w3.org/1999/xlink" xmlns:xsi="http://www.w3.org/2001/XMLSchema-instance"
xsi:schemaLocation="urn:schemas-tiehallinto-fi:digiroad:2003-10 ..\schemas\dr\2003-10\digiroad.xsd">
```

b

```
<dr:digiroadMember>
  <dr:TieElementti fid="tieelementti_67302" dr:guid="36F1D6A02C404E0EA960B161FF36E7D8">
    <gml:boundedBy>
      <gml:null>unknown</gml:null>
    </gml:boundedBy>
    <dr:viiva>
      <gml:LineString srsName="EUREF-FIN">
        <gml:coord>
          <gml:X>25.095194</gml:X>
          <gml:Y>60.481290</gml:Y>
          <gml:Z>55.010000</gml:Z>
        </gml:coord>
        <gml:coord>
          <gml:X>25.095058</gml:X>
          <gml:Y>60.481434</gml:Y>
          <gml:Z>55.030000</gml:Z>
        </gml:coord>
      </gml:LineString>
    </dr:viiva>
    <dr:nimi laji="1" kieli="2">Ldhteenkuja</dr:nimi>
    <dr:tietyyppi>3</dr:tietyyppi>
    <dr:toiminnallinenLuokka>5</dr:toiminnallinenLuokka>
    <dr:kansallinenTieluokka>1</dr:kansallinenTieluokka>
    <dr:eurooppatiennumero>
      <dr:kayttorajoitus>0</dr:kayttorajoitus>
    <dr:liikennevirranSuunta>2</dr:liikennevirranSuunta>
    <dr:liikennemaara>0</dr:liikennemaara>
    <dr:ruuhkautumisherkkyyys>0</dr:ruuhkautumisherkkyyys>
    <dr:tieosanTalonumerot>
      <dr:talonumero>0</dr:talonumero>
    </dr:tieosanTalonumerot>
    <dr:mitattuPituus>0.000000</dr:mitattuPituus>
    <dr:maisemallinenArvo>0</dr:maisemallinenArvo>
    <dr:tienumero>0</dr:tienumero>
    <dr:tieosanumero>0</dr:tieosanumero>
    <dr:elementtiOpastustaulunInfoMember xlink:type="simple" xlink:href="#opastustauluninformaatio_2242"/>
    <dr:elementtiVaylaMember xlink:type="simple" xlink:href="#vayla_1"/>
  </dr:TieElementti>
</dr:digiroadMember>
</dr:Digiroad>
```

Example from schema – road element

Below there is an example from an xml message of road element. With the help of the example essential parts of describing features are presented.

```

<dr:digiroadMember>
  <dr:TieElementti fid="tieelementti_67302" dr:guid="36F1D6A02C404E0EA960B161FF36E7D8">
    <gml:boundedBy>
      <gml:null>unknown</gml:null>
    </gml:boundedBy>
    <dr:viiva>
      <gml:LineString srsName="EUREF-FIN">
        <gml:coord>
          <gml:X>25.095194</gml:X>
          <gml:Y>60.481290</gml:Y>
          <gml:Z>55.010000</gml:Z>
        </gml:coord>
        <gml:coord>
          <gml:X>25.095058</gml:X>
          <gml:Y>60.481434</gml:Y>
          <gml:Z>55.030000</gml:Z>
        </gml:coord>
      </gml:LineString>
    </dr:viiva>
    <dr:nimi laji="1" kieli="2">Ldhteckuja</dr:nimi>
    <dr:tietyyppi>3</dr:tietyyppi>
    <dr:toiminnallinenLuokka>5</dr:toiminnallinenLuokka>
    <dr:kansallinenTieluokka>1</dr:kansallinenTieluokka>
    <dr:eurooppatiennumero>
    <dr:kayttorajoitus>0</dr:kayttorajoitus>
    <dr:liikennevirranSuunta>2</dr:liikennevirranSuunta>
    <dr:liikennemaara>0</dr:liikennemaara>
    <dr:ruuhkautumisherkkyys>0</dr:ruuhkautumisherkkyys>
    <dr:tieosanTalonumerot>
      <dr:talonumero>0</dr:talonumero>
    </dr:tieosanTalonumerot>
    <dr:mitattuPituus>0.000000</dr:mitattuPituus>
    <dr:maisemallinenArvo>0</dr:maisemallinenArvo>
    <dr:tiennumero>0</dr:tiennumero>
    <dr:tieosanumero>0</dr:tieosanumero>
    <dr:elementtiOpastustaulunInfoMember xlink:type="simple" xlink:href="#opastustauluninformaatio_2242"/>
    <dr:elementtiVaylaMember xlink:type="simple" xlink:href="#vayla_1"/>
  </dr:TieElementti>
</dr:digiroadMembe
  
```

1. FID is the reference key inside the message.
2. Every Digiroad feature has its own identifiable guid identifier which is a reference to features in data storage.
3. Gml definition of a feature including geometry. Digiroad features are points (service - palvelu), lines (road element - tie-elementti) and areas (enclosed traffic area - liitännäisliikennealue).
4. Defining attribute data of the feature.
5. The relations of a feature to features in other feature classes are indicated as links where there is a reference to the name of feature class and FID identifier (internal reference key) in the feature message. For example road element has relation to route element, so road element (tieelementti_67302) is one feature in route element (vayla_1). Later the message describes the route element with its attribute data.

APPENDIX 8: CLASS CHART OF DIGIROAD XML R DELIVERY FORMAT

DIGIROAD XML Scheman luokat

