



Väylävirasto
Trafikledsverket

*Finnish Transport Infrastructure Agency
Publications*

Digiroad

*Description of data objects 3/2022
August 2022*



Picture: Digiroad

E-publication (pdf) (www.vayla.fi/digiroad)

Table of contents

1	WELCOME!	3
2	GLOSSARY	4
3	GENERAL INFORMATION ON DIGIROADI	6
3.1	Data sources and data collection	6
3.1.1	Data quality	6
3.2	Data structure in Digiroad	7
3.2.1	Road link	7
3.2.2	Lineary referred attribute data	8
3.3	Coordinate reference systems and height systems	9
3.3.1	Release and delivery formats	9
3.3.2	Digiroad R	10
3.3.3	Digiroad K	11
3.3.4	WMS ja WFS interfaces	11
3.3.5	TN-ITS interface	11
4	ROADLINK ATTRIBUTE DATA	12
4.1	Roadlink attribute data	12
4.1.1	Administrative class	12
4.1.2	Functional class	12
4.1.3	Direction of traffic flow	14
4.1.4	Road link type	14
4.1.5	Bridge, underpass or tunnel	15
4.1.6	Address data	15
4.1.7	Road address data	16
4.1.8	Geometric accuracy	16
4.1.9	Digitisation direction in relation to the geometry of National Land Survey of Finland	17
4.1.10	Link phase	18
4.1.11	Source of the link geometry	18
4.1.12	Road address growth direction	18
4.1.13	Other attribute data of the road link	18
4.2	Restricted manoeuvre	19
4.3	Point attribute data	21
4.3.1	Public transport stop	22
4.3.2	Barrier	24
4.3.3	Traffic Light	24
4.3.4	Pedestrian crossing	25
4.3.5	Directional traffic sign	25
4.3.6	Traffic signs	26
4.3.7	Railway crossing	38
4.4	Line Attribute data	39
4.4.1	Speed limit	39
4.4.2	Maximum allowed ... x 7	39
4.4.3	Lit road	40

4.4.4	Paved road.....	40
4.4.5	Road affected by thawing.....	41
4.4.6	Width	41
4.4.7	Road work.....	42
4.4.8	Parking restriction.....	42
4.4.9	Road treatment class.....	42
4.4.10	Private roads with road associations	43
4.4.11	Traffic volume.....	44
4.4.12	Vehicle-specific restriction.....	44
4.4.13	Restriction for the transportation of dangerous goods (VAK)	45
4.4.14	Number of lanes.....	46
4.4.15	Public transport lane.....	46
4.4.16	E-road number	47
4.4.17	Exit number	47
4.4.18	Winter speed limit.....	47
4.5	Other features.....	48
4.5.1	Service.....	48
5	APPENDICES.....	50
5.1	Appendix 1. Description of data content - field names, data types and code values	51
5.2	Appendix 2. Public transport stop facility data and other attribute data	81
5.3	Appendix 3. Primary data sources by data objects.....	83
5.4	Appendix 4. Time domain character string	85
5.4.1	General.....	85
5.4.2	Time Domain combinations.....	88
5.4.3	Examples.....	88

1 Welcome!

Digiroad is a national database that contains the geometry of the Finnish road and street network featured with the most important road attribute data.

This document provides a detailed description on the Digiroad data features.

More info on Digiroad can be found at our [website](#).

We are happy to help with all matters concerning Digiroad:

info(a)digiroad.fi

tel. +358 40 507 2301

2 Glossary

Digiroad Information System

The Digiroad information system is a national road and street database for which Finnish transport infrastructure agency is responsible and which includes centre line geometry of streets and roads and traffic attribute data.

JHS

Central and local government information management is governed by JHS recommendations (Public Administration Recommendation). JHS refers to a uniform method, specification or guideline issued for the use of central and local government administration.

Centre line geometry

Digiroad centre line geometry is formed by line segments that describe the positions of centre lines of roads, streets, walking and cycling lanes and ferry connections.

Traffic network

Traffic network is an entity consisting of road links connected to each other with nodes. The Digiroad traffic network is topologically consistent, with the exception of certain road links, for examples on islands.

Linear referencing

Linear referencing is a method of indirect spatial referencing in which a position is located by a known point in a linear reference frame (a road link in Digiroad).

Linear reference frame

Linear reference frame is a line geometry from which position in relation to a known point on a line can be determined, for example according to a measure value like in Digiroad.

Linearly referenced object

Linearly referenced feature is a section in the Digiroad road network without a geometry. The feature is located from the road network dynamically by measure values.

Measure value, M value

Measure or M value is attribute data of linear geometry that helps to define the position on a line unambiguously.

Attribute data

Attribute data is an entity of identifiable, timetable and descriptive properties of a feature. Data objects themselves are attribute data for the road network. In addition, there are data object specific attribute data, such as the type of public transport stop and validity direction.

Features of traffic system

A feature of traffic system is an independent part of the system. For example, a public transport stop is a feature of traffic system with its unique attribute data. The position of the feature may be saved by linear referencing or it may have a position outside the traffic system, indicated by coordinate data.

Point attribute data

Point attribute data refers to attribute data that have a point as the geometric shape of its position. Point attribute data has no M value, with which it could be referenced on the road link geometry. That makes point attribute data separate from the road network. In Digiroad, point attribute data refers to a service.

Point segment

Point segment refers to attribute data whose indirect position is a location in the road link, i.e. a measure. The geometric shape, formed by linear referencing of the attribute data, is a point.

Segment

In Digiroad, a segment refers to road link attribute data that has no geometry of its own. A segment is dynamically located in the road link with M values. There are point and line segments.

Position

In Digiroad, position refers to feature attribute data given by coordinates.

Road link

A linear data object describing the traffic network geometry.

Road link attribute data

Road link attribute data refer to attribute data describing a road link across its entire length. Road link attribute data include data such as functional class, direction of traffic flow and Link-ID.

Data object

Data object refers to traffic network attribute data such as a speed limit or a public transport stop.

Line segment

Line segment refers to attribute data whose indirect position is the distance between two measures on a road link. Line is the geometric shape formed by linear referencing of attribute data.

3 General information on Digiroad

Digiroad is a national road and street information system which includes centre line geometry of streets and roads, traffic attribute data and the features of the traffic system.

Centre line geometry includes vehicle accessible roads, ferry and cable ferry connections for vehicles, and separate pedestrian and cycle lanes.

Traffic attribute data refer to data such as speed limits, permitted traffic flow directions as well as weight and height limits.

Digiroad data can be applied to e.g. services, analyzes and applications related to traffic and navigation.

This document describes the structure and data objects of Digiroad. In this description, data objects have been divided into attribute data of road links, point attribute data, and linear attribute data.

Name and identifiers	Digiroad, F11000018
References	INSPIRE Data Specification on Transport Networks (17.4.2014) INSPIRE Generic Conceptual Model (18.6.2010) JHS 177 Paikkatietotuotteiden määrittely (21.10.2010)
Information about definition	Name: Digiroad Date: 23rd May 2016 Author: Finnish transport infrastructure agency Language: Finnish
Meta-data	http://www.paikkatietohakemisto.fi/geonetwork/srv/fin/catalog.search;jsessionid=1656b74vwr8aj1a46gg3gievzt#/meta-data/34155a94-b58b-4ad0-87e6-f96d2db0f3ba

3.1 Data sources and data collection

The National Land Survey of Finland, the Finnish transport infrastructure agency, municipalities, road association and a few other authorities provide source data for Digiroad. Digiroad data covers the entire Finland. Data collection is based on the Law of the data system of road and street network 28.11.2003/991. The primary data sources are specified according to the data objects in Appendix 3. The Digiroad operator is responsible for harmonizing and integrating the material produced by different vendors into one country-wide material.

3.1.1 Data quality

For the time being, quality reports or other documents related to data quality are not published regarding Digiroad data objects.

Coverage and accuracy	<i>Digiroad data covers the entire Finland. The quarter who utilizes the data should take into account that the maintenance of Digiroad data objects by municipalities is varied. Therefore, the data quality in different parts of the material varies considerably. The road network data is mostly maintained in the road register by the Finnish Transport infrastructure agency. This data may also vary regionally.</i>
Logical integrity	<i>The data is conceptually and topologically sound.</i>
Geometric accuracy	<i>The geometric accuracy of the road links is approximately 3 metres.</i>
Temporal accuracy	<i>The date when the geometry has been extracted from the NLS topographic database is announced when the material is released. All features in Digiroad data have a last modified date in the release. Digiroad data is maintained continuously.</i>
Thematic accuracy	<i>Not known.</i>

3.2 Data structure in Digiroad

The Digiroad information system contains information on the centre line geometry of the road network as well as traffic attribute data. The centre line geometry of the Digiroad network of roads and streets consists of road links joined together with nodes. Each road link has a node at both ends. With regard to geometry, road links are linear objects whereas nodes are point objects.

3.2.1 Road link

A road link is the basic unit of centre line geometry. As regards their length, road links usually cover the distance between intersections but they can also be shorter. Road links may be split between intersections if an administrative class or road link attribute data (name, surface type) changes. A more detailed description of road links can be found in the JHS188 recommendation. The length of road links is already defined in the NLS topographic database in which the road links utilized in Digiroad are maintained. Some of the data objects in Digiroad are attribute data of road links, and these attribute data always cover the length of the entire road link. Examples of such data objects are road name, road address, and traffic flow direction.

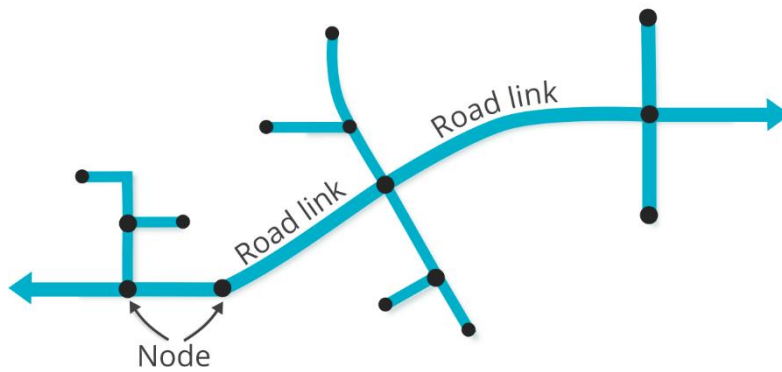

Image 1. Digiroad network of roads and streets consists of road links.

An M value has been attached to the geometry of a road link. The M value and the road link are used for locating attribute data by means of linear referencing.

3.2.2 Linearly referred attribute data

Some of Digiroad's data objects are attribute data that have been attached to road links by means of linear reference frame. These data objects can be either linear or point-form, and they need not be of the same length as the entire road link. Linearly referenced attribute data do not have their own geometry but refer to a road link and a position on the road link. In Digiroad, however, a geometry has been generated for each attribute data based on road link geometry.

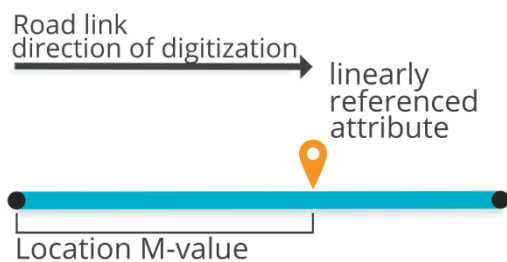

Image 2: Linearly referenced point attribute data for road links (e.g. public transport stop).

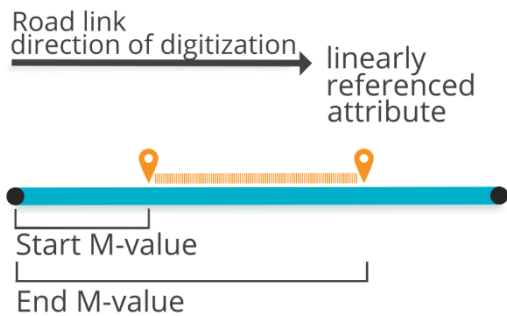

Image 3: Linearly referenced line attribute data for road links (e.g. speed limit).

The M value represents a position on the road link, i.e. the distance from the start point of the road link. The start M value determines the distance from the start point of the road link to the start of the attribute data, and the end M value determines the distance from the start point of the road link to the end of the attribute data. A single M value refers to point reference data whereas line attribute data has both start and end M values. The start M value for all road links is 0. Moreover, the start M value is a calculatory measure and does not directly correspond to e.g. the actual length of a road link in metres although the difference is usually not significant.

3.3 Coordinate reference systems and height systems

Digiroad uses the EUREF-FIN coordinate reference system as well as the ETRS-TM35FIN projection (EPSG: 3067) which is based on UTM projection. Moreover, Digiroad uses a rectangular coordinate system in which coordinate points have a north coordinate and an east coordinate. The coordinates are given in metres and marked with letters 'P' and 'I'. The heights of road network objects in Digiroad are based on height data in the topographic data-base, and the height data derives from elevation model 2 m which covers the whole of Finland. If elevation model 2 m is unavailable, the height data will be derived from elevation model 10 m.

As the EUREF-FIN coordinate reference system deviates from the WGS84 coordinate reference system by less than one metre, the two systems can be considered congruent for most purposes.

3.3.1 Release and delivery formats

The latest Digiroad data can be downloaded from the Finnish Transport infrastructure Agency's distribution service for open datasets: <https://ava.vayla-pilvi.fi/ava/Tiestötiedot/Digiroad>

Previous releases are available in the same distribution service: <https://aineistot.vayla.fi/digiroad/>.

The file format for extracted data is ESRI Shapefile. From publication 2/2018 onwards the data is available also in GeoPackage format.

The data itself is released in two different exports:

- Digiroad R export, files according to the export area
- Digiroad K export, files according to the export area

Both delivery formats contain road link geometry as well as linear and point data objects as their own separate shapefiles. Thus, each data object and its attribute data can be utilized as independent material.

Both delivery formats have the exact same data content as regards data objects and their attribute data.

Below is a more detailed description of the characteristics of both delivery formats.

3.3.2 Digiroad R

Digiroad R is a delivery format in which the length of both road link geometry and linear data objects generally equals to the distance between intersections. Point objects do not split road links or linear objects.

When necessary, data objects can be attached to road links by linear referencing. The referencing process utilizes the LINK_ID tag included in each shapefile as well as the m-values for objects. The location of linear objects as well as the start and end points of their length is given as m-values.

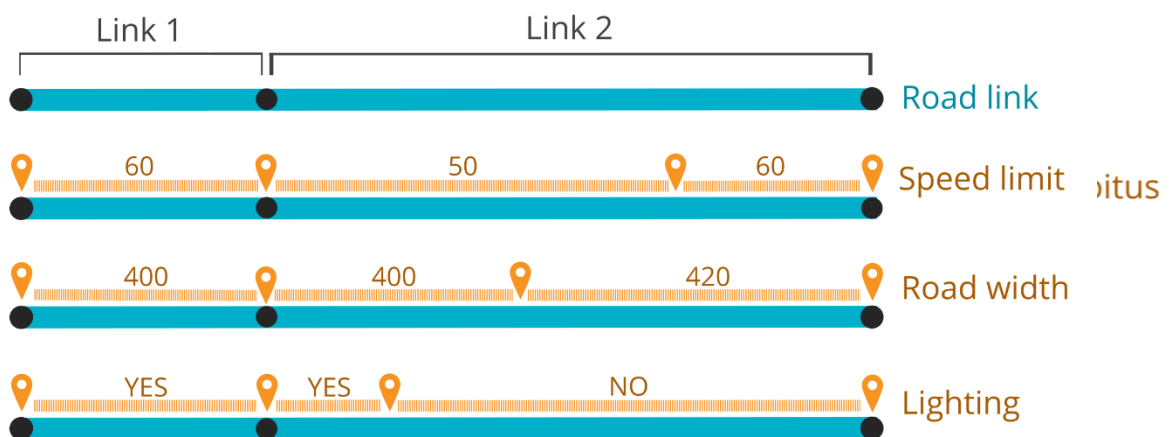

Image 4: In Digiroad R, the position of data objects has been referenced linearly.

3.3.3 Digiroad K

Digiroad K is a delivery format in which road links and shapes that contain linear data objects have been formed in the way that the geometry of both road links and all data objects is split if any attribute data changes. Consequently, the data may also contain very short links. Point data objects do not, however, split the geometry of road links or linear data objects. The split links have the same link_ID if they form a single uniform object in the topographic database (or in Digiroad R). Furthermore, the split links have been identified by a separate identifier, SEGM_ID.

This identifier consists of the code or number for the municipality where the segment is located as well as a consecutive number generated in the splitting order. If the links in the image below were located in the Helsinki area, their segment IDs would be as follows: LINK_ID = 1; SEGM_ID = 91_1, LINK_ID = 2; SEGM_ID = 91_2, 91_3, 91_4, 91_5). The same SEGM_ID is inherited to all shape-files describing different data objects. The identifier for a disconnected link is delivery-specific.

The delivery format of Digiroad K export is suitable for use with e.g. MapInfo (version 7 or later).

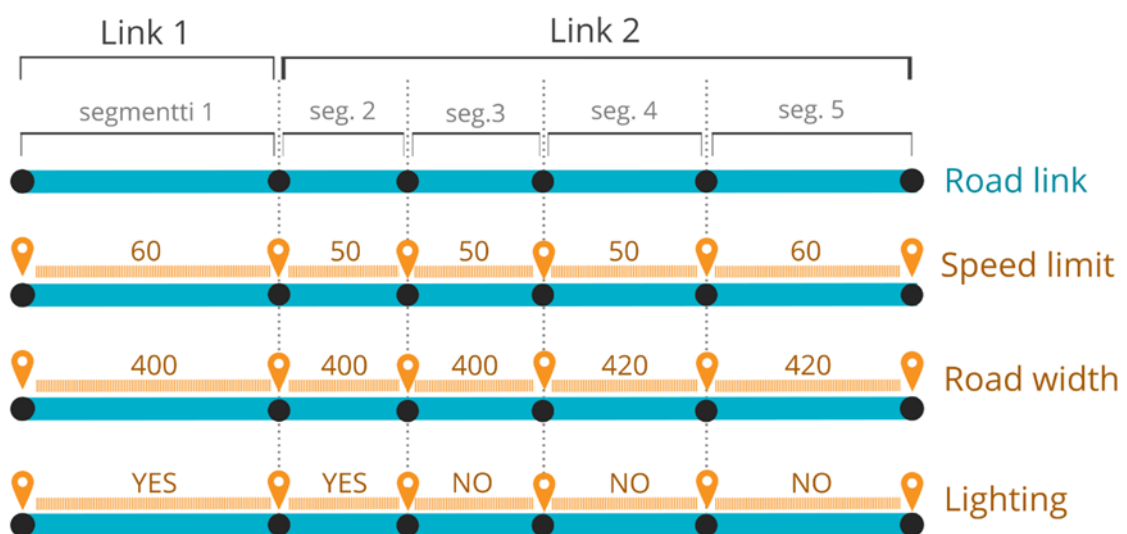

Image 5: In Digiroad K, the road links have been split into homogenous parts based on their attribute data.

3.3.4 WMS ja WFS interfaces

Digiroad is also published on the Vaylän (Finnish transport infrastructure agency) view and download service by data type via the WMS and WFS interface service. The WFS interface works best with municipal boundaries and instructions for utilization can be found on the Digiroad interface page.

3.3.5 TN-ITS interface

Changes related to speed and weight limits in Digiroad data are released once a day as an xml file through the TN-ITS interface. A link to the interface can be found on the Digiroad website.

4 Roadlink attribute data

This chapter provides information on the data objects used in the new Digiroad system. The definition of the object, attribute data, code values and data type of attribute data, and data coverage are given for each data object.

For the fields corresponding to the attribute data in the Digiroad export, please see Appendix 1, Description of data content.

4.1 Roadlink attribute data

The Digiroad traffic network includes vehicle accessible roads, vehicle tracks, ferry and cable ferry connections for vehicles, and separate pedestrian and cycle paths. The road link geometry is provided by the National Land Survey of Finland. The road link attribute data applies to the entire distance of a road link.

4.1.1 Administrative class

Definition

The administrative class assigns a state, municipality or private owner to a road link. The administrative class does not describe which municipality or road association owns the road. The administrative class is maintained by the National Land Survey of Finland from the beginning of 2016.

Coverage

Data is included for all road links excluding walking and cycling paths and vehicle tracks.

Abbreviation in the Road Link table

[HALLINN_LK](#)

Administrative class		
Owner type	Code value	Description
State	1	Road is owned by the state (road).
Municipality	2	Road is owned by a municipality (street).
Private	3	The road is privately owned, for example by a road association.
Not known	99	No data

4.1.2 Functional class

Definition

The functional class describes the importance of a route for traffic. Function -al class describes:

- Service level of route to the traffic
- Intention of the route maintainer to direct traffic to the route.

The functional classes of roads largely follow the Finnish Transport infrastructure Agency's road classification (class I, class II, regional and connecting roads).

Functional classes of streets may be determined by municipalities. The basis for the classification is the one used in the land use plan. If a road continues as a street, municipal boundaries and the functional class of the road also affect the classification. The functional classes of private roads are determined in accordance with the importance, width and condition of the road.

Coverage

Data applies to all road links.

Abbreviation in the Road Link table

[TOIMINN LK](#)

FUNCTIONAL CLASS		
Functional class	Code value	Description
Class I main road or regional main street	1	<p>Main roads are the principle roads in the Finnish road network. In the Finnish road numbering system, main roads are numbered from 1 to 39.</p> <p>Regional main street serves mainly long distance or transit traffic and incoming traffic. There may also be traffic within the municipality on a regional main street. In terms of traffic, more important than code value 2 regional main street.</p>
Class II main road or regional main street	2	<p>Class II main roads are part of the Finnish road network complementing the class I network and serving regional traffic. Together with the class I main roads they form the network of Finland's main roads.</p> <p>Regional main street serves mainly long distance or transit traffic and incoming traffic. There may also be traffic within the municipality on a regional main street.</p>
Regional road or local main street	3	<p>Regional roads belong to the Finnish road network serving regional traffic and providing connections to class I and II main roads.</p> <p>Local main street serves mainly traffic within a municipality, e.g. from a suburb to the city centre or the traffic between different surrounding areas. There may also be long-distance, transit or incoming traffic on a local main street.</p>
Connecting road or collector street	4	<p>Connecting roads are roads in the Finnish road network that are not class I or II main roads or regional roads.</p> <p>Collector street collects traffic from a traffic cell to main streets and roads. There should be no through traffic on collector streets in the traffic cells.</p>
Feeder street or class I private road	5	<p>Feeder street connects land use with collector streets and roads. There is a direct connection from a feeder street to a plot of land or a building site.</p> <p>The use of class I private road is commonly allowed and it can be used throughout the year. Typically a class I private road is very important for the traffic in the area and there is also a road association that has been established and it has received funds from the state or municipality.</p>
Class II private road	6	<p>Class II private roads include all other private roads, excluding private and forest roads, which are not in class I private roads and which are accessible by vehicles.</p>
Vehicle track	7	<p>Vehicle tracks are other private or forest roads, which may not be accessible by car but can be used by pedestrians, bicycles or off-road vehicles. Vehicle tracks can connect with the road network</p>

		without a common end point. This is a new class added to the Digiroad data model.
Pedestrian and cycle path	8	Walking and cycling paths are mainly used by pedestrians and bicycles and, in some cases, mopeds.
	99	No data, when the road link status is under construction

4.1.3 Direction of traffic flow

Definition

The direction of traffic flow is determined in relation to the direction of digitization of a road link.

Walking and cycling paths may also be described as one-way if the traffic is only allowed in one direction.

Coverage

Data applies to all road links.

Abbreviation in the Road Link table

[AJOSUUNTA](#)

DIRECTION OF TRAFFIC FLOW	
Direction of traffic flow	Code value
Traffic is permitted in both directions	2
Traffic is permitted against the direction of digitization	3
Traffic is permitted in the direction of digitization	4

4.1.4 Road link type

Definition

The road link type describes the physical or traffic attribute data of a road link.

The type of ferry / ferry link describes the ferry and ferry routes that are an extension of the road network, they do not describe waterways

Coverage

Data applies to all road links.

Abbreviation in the Road Link table

[LINKKITYYP](#)

ROAD LINK TYPE	
Road link type	Code value
Part of a motorway	1
Part of a multiple carriageway, which is not a motorway	2
Part of single carriageway	3
Part of a semi-motorway	4
Part of a roundabout	5
Slip road	6
Rest area	7
Walking and cycling path	8
Part of a pedestrian zone, e.g. a pedestrian street or footpath	9
Part of a service or emergency road	10
Enclosed traffic area	11

Vehicle track, roads accessible by off-road vehicles	12
Service access point on a motorway	13
Route for special deliveries without a locked barrier structure	14
Route for special deliveries with a locked barrier structure	15
Ferry/cable ferry	21
Not known	99 (no data, when the status of the road link is under construction)

4.1.5 Bridge, underpass or tunnel

Definition

Road link, which is a bridge, underpass or tunnel. The other one of the centre line geometries crossing each other on different levels has a definition underpass while at the same point the other link gets the definition bridge (although in actual fact lowest/upper road link is at the ground level).

The bridges that cross each other are classified according to their level in the following way: the first bridge from the ground level gets the value 1, the second one gets the value 2, etc.

The levels below the ground are marked with values -2 and -3 in the way that the -2 level is closer to the ground level.

Coverage

Data applies to all road links.

Abbreviation in the Road Link table

[SILTA_ALIK](#)

Bridge, underpass or tunnel	
Bridge, underpass or tunnel	Code value
Tunnel	-11
Underground level	-3
Underground level	-2
Underpass	-1
At the Ground level	0
Bridge, level 1	1
Bridge, level 2	2
Bridge, level 3	3
Bridge, level 4	4

4.1.6 Address data

Definition

A road's name, which has a road number, road part number, carriageway information and start and end distance from the beginning of the road part.

The name of the road is the name of the road according to the official address system of the municipality. The address numbers of the house are always in proportion to the digitization direction of the road link.

Along has the same road number

The road link address data include street names in Finnish, Swedish and Sami (if present), the first house on the right and left, the last house on the right and left, and the municipality code.

If the road link does not have address numbers, the field value 0 / null (No data) (in the Digiroad releases) is used. If a link is located in the border of two municipalities the municipality code refers to the municipality in which link is mostly located in. The municipality codes consist of one to three digits, no initial zeros are added (eg. Helsinki 91).

Abbreviation in the Road Link table

[TIENIMI_SU](#); [TIENIMI_RU](#); [TIENIMI_SA](#); [ENS_TALO_V](#); [ENS_TALO_O](#); [VIIM_TAL_V](#); [VIIM_TAL_O](#); [KUNTAKOODI](#)

4.1.7 Road address data

Definition

Road link including a road number and the number of the part of the road, carriageway and start and end distance for the road link (from the beginning of the road part).

Since Åland and the mainland share the same road numbering space, the road links in Åland have the same road numbers as in the continental Finland.

Coverage

Information applies to all state-owned roads.

Abbreviation in the Road Link table

[TIENUMERO](#); [TIEOSANRO](#); [AJORATA](#); [AET](#); [LET](#)

4.1.8 Geometric accuracy

Definition

The accuracy of the horizontal position of the road link is a metric class, for example 3 metres.

Abbreviation in the Road Link table

[SIJ_TARK](#); [KOR_TARK](#)

Geometric accuracy	
Accuracy of the horizontal position	Code value
Not defined	0
0,5 m	500
0,8 m	800
1 m	1000
2 m	2000
3 m	3000
4 m	4000
7 m	5000
7,5 m	7500
8 m	8000

10 m	10000
12,5 m	12500
15 m	15000
20 m	20000
25 m	25000
30 m	30000
40 m	40000
80 m	80000
100 m	100000

If the vertical accuracy information for the road link is interpolated from the height model, the code is either "KM10" (traced from the 10 m resolution height model), or "KM25" (traced from the 25 m resolution height model).

Vertical accuracy	
Vertical accuracy	Code value
Not defined	1
KM 2 m	201
0,5 m	500
0,8 m	800
1 m	1000
2 m	2000
3 m	3000
4 m	4000
5 m	5000
7,5 m	7500
8 m	8000
10 m	10000
12,5 m	12500
15 m	15000
20 m	20000
25 m	25000
30 m	30000
40 m	40000
80 m	80000
100 m	100000
KM 10 m	100001
KM 25 m	250001

4.1.9 Digitisation direction in relation to the geometry of National Land Survey of Finland

Definition

With the assistance of this field it can be deduced, if the direction of the digitization has changed in relation to the direction of digitization mentioned in the topographic database of the National Land Survey of Finland.

Abbreviation in the Road Link table

GEOM_FLIP

DIRECTION OF TRAFFIC FLOW	
Direction of traffic flow	Code value
Direction of digitization remained the same	0
Changed direction of digitization	1
Not known	null

4.1.10 Link phase

Definition

Road link phase specifies, whether the road link is in use, under construction or planned. Link will be defined as "planned" if an investment decision has been made.

Abbreviation in the Road Link table

[LINK_TILA](#)

LINK PHASE	
Link phase	Code value
Digitisation direction remains the same	Null
Under construction	1
Planned	3

4.1.11 Source of the link geometry

Definition

Source of the road link specifies, whether the link geometry derives from the National Land Survey or some other data source. Other sources remain un-specified at least at this stage. If a need for a more detailed information concerning the sources arises in the future, this classification can be specified.

Abbreviation in the Road Link table

[GEOM_LAHDE](#)

SOURCE OF LINK GEOMETRY	
Geometry source	Code value
National Land Survey	1
Other, not specified	2

4.1.12 Road address growth direction

Definition

The growth direction of the road address indicates the direction of storage of the road address in the road register

Abbreviation in the Road Link table

[TIEN_KASVU](#)

Road address growth direction	
Road address growth direction	Code value
The road link in the direction of digitization	1
The road link against the direction of digitization	2
Not known	Null

4.1.13 Other attribute data of the road link

The other attribute data of the road link include:

- The date of the last edition MUOKKAUSPV
- Link ID
- LINK_MML_ID

- The M value of the start and the end point of the link ALKU_PAALU ja LOPP_PAALU
- The attribute data also includes road classification according to the topographic database by the National Land Survey (MTK_TIE_LK). The information included in the classification is described more specifically in National Land Survey's website (www.maanmittauslaitos.fi).

4.2 Restricted manoeuvre

Definition

Restricted manoeuvre indicates prohibited or blocked manoeuvres.

Restricted manoeuvre data refers to the relation between road links. Restricted manoeuvre consists at least of the related start and end links (U-turns can consist of up to four links), period of validity, exceptions and additional data. Exceptions indicate the vehicles to which the restriction is not applied.

Manoeuvre data is carriageway specific, not lane specific. Restricted manoeuvre can exist between road links only if turning to another road link is forbidden from each lane.

In Digiroad, no such restricted manoeuvre is maintained that is forbidden by the Road Traffic Act. These include, for example turning to one-way road link against the direction of the traffic flow or turning to walking and cycling path.

Coverage

Information applies to roads, streets and private roads.

Link to the Restricted manoeuvre_link table

[Restricted manoeuvre](#)

[Restricted manoeuvre_link](#)

RESTRICTED MANOEUVRE	
Exception to the restricted manoeuvre	Code value
Truck	4
Bus	5
Van	6
Passenger car	7
Taxi	8
Motorcycle	9
Moped	10
Articulated vehicle	13
Tractor or farm vehicle	14
Car with trailer / recreational vehicle	15
Military vehicle	19
Driving in service purposes	21
Driving to a lot	22
Snow mobile	27

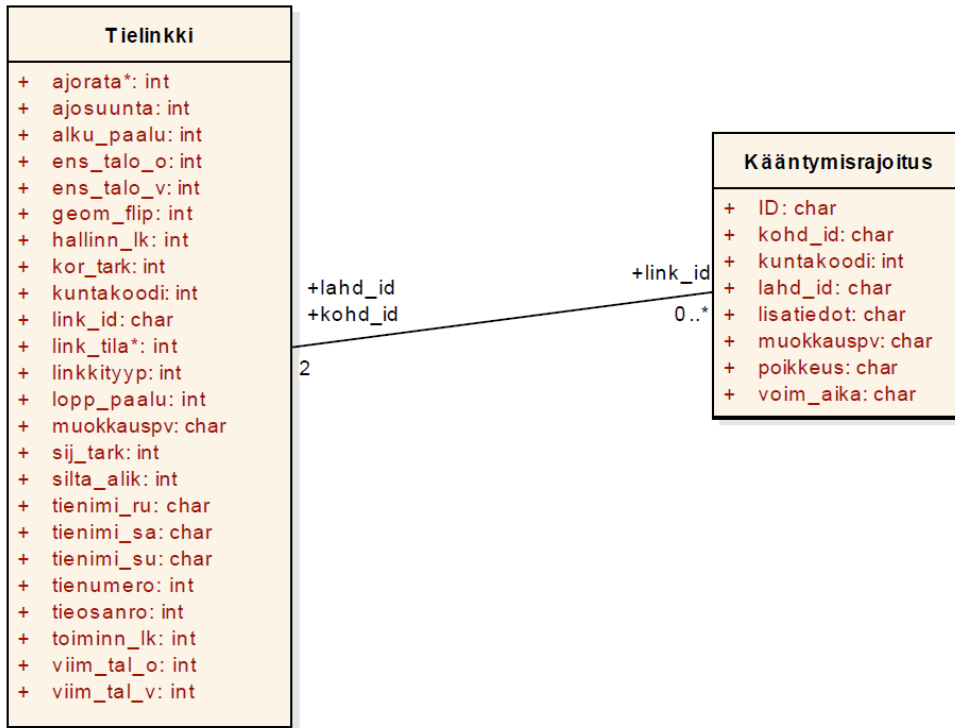

Image 6: Restricted manoeuvre can be joined to road links according to the source link ID information and the object link ID information.

The connected start (source), intermediate, and end (destination) links for the turn restriction are in the Turn Restriction_Link table. The table is a dbf file in the Digiroad publication and is currently only included in the Digiroad R delivery format.

Restricted manoeuvre link			
Feature information	Data type	Description	Code value
Restricted manoeuvre ID	Numeric	Identification of the Restricted manoeuvre	-
Link-ID	Numeric	Identification of the road link	-
Status	Koodiarvo	Road links role in Restricted manoeuvre	1 start (source) link 2 intermediate links 3 end (destination) link
Sequence number in Restricted manoeuvre	Numeric	Road link sequence number in a turn restriction. The sequence number of the Al-ku (source) link is zero	-

4.3 Point attribute data

Point attribute data refer to linear referencing attribute data that have only one *M* value which is the distance from the start of the link. All point attribute data objects have at least the following data:

POINT ATTRIBUTE DATA		
Attribute data	Data type	Description
ID*	Numerical	The ID identifying the object
Link ID	Numerical	The link ID of the link where the object is located.
Distance from the start of the link	Numerical	The position of the object on a road link measured from the start.
Last edited	Character string	Time last edited or added to the system.
Municipality code	Code value	Municipality code of the object.

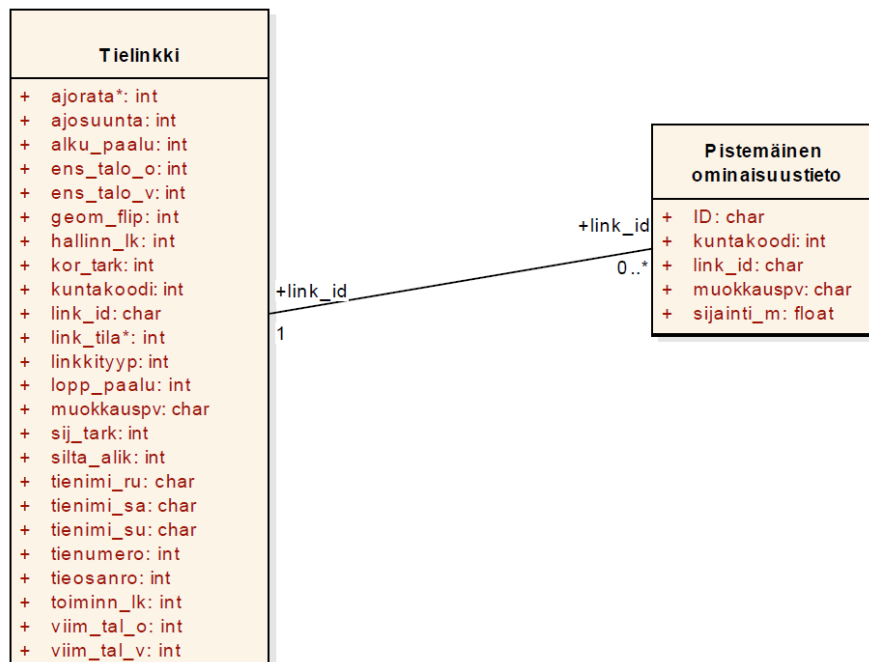

image 7: Figure: Point attribute data can be joined to the road links by linear referencing, according to the link ID attribute data and *M* values.

Tielinkki = Road link

Pistemäinen ominaisuustieto = Point attribute data

4.3.1 Public transport stop

Definition

A stop used by public transport.

The position of the public transport stop either refers to the position in the material provided or a position assigned to the stop in the user interface. In the interface, the position of the stop is generated by linear referencing. In this case, the road link of the stop and the M value determining its position on the road link are known. In addition, the stop is assigned by its coordinates (x, y) in the interface. The position given by the data provider is indicated in the fields X (east coordinate), Y (north coordinate) and Z (height). These coordinates are as-signed in the user interface and do not necessarily match with the linearly referenced positions.

For public transport stop facility data and other attribute data, please see Appendix 2.

Coverage

A public transport stop can be located on any road link with the exception of walking and cycling paths, ferries and cable ferries.

Link to the Public transport stop table

[Public transport stop](#)

PUBLIC TRANSPORT STOP			
Attribute data	Data type	Description	Code values
Coordinate X (east coordinate)	Numerical	X coordinate of the stop in the Digiroad database. Calculated using the road link and M value.	
Coordinate Y (north coordinate)	Numerical	Y coordinate of the stop in the Digiroad database. Calculated using the road link and M value.	
Link ID	Numerical	The Link-ID of the road link where the stop is located*	
M value	Numerical	Stop position on the road link*	
Validity direction	Code value	Stop validity direction in relation to the direction of digitisation of a road link*	2 In the direction of digitisation 3 Against the direction of digitisation
Last edited	Character string	The date the object was last modified.	
National ID	Numerical	Nationally unique identifier for the stop.	
Name in Finnish	Character string	Name of the stop in Finnish.	
Name in Swedish	Character string	Name of the stop in Swedish.	
Data administrator	Code value	Authority administering the data in Digiroad.	1 Municipality 2 Centre for Economic Development.

			Transport and the Environment (ELY Centre) 3 Helsinki Regional Transport 4 Not known
Administrator identifier	Character string	The unique identifier assigned to the stop by the administrator in their own system.	
Livi identifier	Character string	The stop Livi identifier that corresponds to the identifier in the road register. Only applies to stops on the roads.	
Traveller identifier	Character string	The stop identifier physically displayed at the public transport stop.	
Ground coordinate X (east coordinate)	Character string	The calculated X coordinate of the stop's location. Ground coordinates are provided by the data administrator and may not correspond to those given in the application.	
Ground coordinate Y (north coordinate)	Character string	The calculated Y coordinate of the stop's location. Ground coordinates are provided by the data administrator and may not correspond to those given in the application.	
Ground coordinate Z	Character string	The calculated Z coordinate of the stop's location. Ground coordinates are provided by the data administrator and may not correspond to those given in the application.	
Direction of travel	Character string	Free description of the direction of the stop.	
Traffic bearing	Numerical	Degree between 0 and 360. Describes the stop validity direction.	
Valid from date	Time stamp	Date when the stop is first used.	
Valid to date	Time stamp	Date when the stop is used for the last time.	
Stop type	Code value	The stop type indicates the type of traffic served by the stop. A stop may be assigned more than one type.	1 Tram 2 Local transport 3 Long-distance transport 4 Express bus 5 Virtual stop 6 Terminal 99 No data
Disconnected from geometry**	Code value	The geometry of the road link where the stop is located has changed considerably, disconnecting the stop from the geometry.	1 Connected to geometry 2 Disconnected from the geometry
Zone	Character string	Zone Information for WH Areas Using Flag Zones: eg A, B, C	

Service level class	Code value	Stops are classified according to the use of the stop into eight service level categories	1 Terminal 2 Central knot stop 3 Lively stop 4 Basic stop 5 Little used stop 6 Leaving stop 7 Virtual stop 8 Stops not used for bus services 99 No data
---------------------	------------	---	---

**) If the stop is disconnected from geometry, its Link-ID, M value and validity direction are null.*

****) The expired stops anymore are not updated to the link geometry if the geometry is changed.*

4.3.2 Barrier

Definition

Barriers are blocked passages or traffic barrier gates which can be opened. Blocked passage refers to a physical barrier on the road and street network that prevents passing through. For example, the connection of the streets may be blocked with stones, ditch or a traffic barrier gate which cannot be opened.

A traffic barrier gate which can be opened is a point in a central line geometry which is locked but can be opened.

Coverage

Information applies to streets and private roads.

Link to the Barrier table

[Barrier](#)

BARRIER	
Barrier type	Code value
Blocked passage	1
Traffic barrier gate which can be opened	2

4.3.3 Traffic Light

Definition

Intersection traffic light control is marked as a point segment at the distance of 5 meters from the intersection. It applies on all the links that have direction of travel towards the intersection.

A traffic light that is between intersections is described as a point e.g. beside a pedestrian crossing guided by traffic lights in the case that no intersecting geometry exists.

Coverage

Information applies to roads and streets.

Link to the Traffic light table

[Traffic light](#)

4.3.4 Pedestrian crossing**Definition**

A pedestrian crossing marked with a traffic sign and road markings.

Coverage

Information applies to streets.

Link to the Pedestrian crossing table

[Pedestrian crossing](#)

4.3.5 Directional traffic sign**Definition**

Directional traffic sign and its information are the signposts which are situated on or directing to motorways or semi-motorways. Typically directional sign is located at a junction or just before it. There may be several directions (pieces of information on a directional sign) on a directional traffic sign.



Image 8: Image shows four directions, i.e. four pieces of information, on a directional traffic sign (in a directional traffic sign segment).

Directional traffic sign information contains the following data, separated by a semicolon:

PLACE NAMES;COLOUR;LOCATION

Within the fields, the information is separated by a colon, for example:
"HELSINKI:HELSINGFORS;1;500"

More detailed description of the parts of the character string:

Place names:

- Names of places written as in the directional traffic sign (all CAPITAL letters).

Background colour:

- no data
- green (motorway or semi-motorway)
- blue (road)
- white (local, e.g. a town district)

Location

Distance of the directional traffic sign from the junction in metres.

Coverage

Information applies to streets, roads (1-299), and some private roads. Information is not particularly comprehensive and its quality may vary according to the area.

Link to the Directional traffic sign table

[Directional traffic sign](#)

DIRECTIONAL TRAFFIC SIGN			
Attribute data	Data type	Description	Code values
Validity direction	Code value	Direction of travel in relation to the direction of the digitation on link.	2 In the direction of the digitisation 3 Against the direction of the digitisation
Bearing	Numerical	Degree	
Text	Character string	List of content	

4.3.6 Traffic signs

Definition

Traffic control device that points the start and end point of traffic rules for example speed limits. Traffic sign data include warning signs, priority and give-way signs, prohibitory and restrictive signs, additional panels, mandatory signs, information signs, regulatory signs and service signs. In this data extraction the additional panels are on their individual points. In the future there will be a batch run that joins the correct additional panels to their main traffic signs.

Coverage

The data covers state roads, municipality street network and some private roads. On the street network, the information is maintained by the municipal administrator and on private roads, the information is maintained by the road association. Data is not yet comprehensive for the whole country and there may occur errors in state roads and municipality street network. We are working to improve the quality and coverage of the data in the future.

Traffic signs				
Attribute data	Data type	Description	Code values	
Value	Numerical	Traffic sign value, for example 80 on speed limit sign		
Additional info	Character string	Value of the traffic sign if not numerical		
Status	Code value	The state of the traffic sign	1 2 3 4 5 6	In the works Under construction Permanently enabled (default) Used temporarily Temporarily disabled Permanently disabled
Location	Code value	Where the traffic sign locates on the road	1 2 3 4 5 6 Null	Right side of the lane (default) Left side of the lane Above the lane Central island or traffic divider Longitudinal to the direction of lane Outside the road and street network, for example on a parking area Not known
Damage type	Code value	Damages on a traffic sign	1 2 3 4 null	Rusted Battered Painting Other damage Not known
Size	Code value	The size of the traffic sign	1 2 3 Null	Small sign Normal sign Large sign Not known
Lane	Code value	The lane where the sign locates on		Lane numbering can be checked from the Digiroad Road Traffic Act
Structure	Code value	Specifies the location of the traffic sign	1 2 3 4 5 6 7 Null	Pillar Wall Bridge Portals Half portal Boom or other barrier structure Other Not known
Condition	Code value	The condition of the traffic sign	1 2 3 4	Very bad Bad Satisfactory Good

			5 Null	Very good Not known	
Film type	Code value	The film on a traffic sign	1 2 3 Null	R1 class film R2 class film R3 class film known	
Urgency of repair	Code value	The urgency of repair	1 2 3 4 Null	Great urgency Urgent Somewhat urgent Not urgent Not known	
Material	Code value	Traffic sign material	1 2 3 Null	Plywood Aluminium Other Not known	
Additional plate color	Code value	Color of additional plate	1 2 Null	Blue Yellow Not known	
Additional plate size and film	Code value	The size and film on an additional plate		Same as main traffic signs	
Traffic sign type • Legal number 729/2018 (New) • Old regulation (old)	Code value	Traffic sign code value	New	Old	Name
			A1.1	111	Right bend
			A1.2	112	Left bend
			A2.1	113	Several bends, first bend right
			A2.2	114	Several bends, first bend left
			A3.1	116	Dangerous ascent
			A3.2	115	Dangerous descent
			A4	121	Road narrows
			A5	122	Two-way traffic
			A6	131	Swing bridge
			A7	132	Ferry, quay or river bank
			A8	133	Traffic congestion
			A9	141	Uneven road
			A10	141a	Uneven road
			A11	142	Road works
			A12	143	Loose gravel
			A13	144	Slippery road
			A14	147	Dangerous shoulders
			A15	151	Pedestrian Crossing
			A16		Pedestrians
			A17	152	Children
			A18	153	Cyclists
			A19	154	Ski track
			A20.1	155	Elks
			A20.2	156	Reindeer
			A20.3		Deer
			A21	161	Intersection with
			Equal		Roads
			A22.1	162	Intersection with minor
			A22.2		roads on both sides
			A22.3	163	Intersection with two minor roads on both sides
			A22.4		Intersection with one minor road on the right/left
				164	Diagonal Intersection

					with one cross minor road
			A23	165	Light signals
			A24	166	Roundabout
			A25	167	Tramway line
			A26	171	Level crossing without
					gate
			A27	172	Level crossing with gates
			A28.1	173	Approach level crossing three strips
			A28.2	174	Approach level crossing two strips
			A28.3	175	Approach level crossing one strip
			A29.1	176	Level crossing with one
					track
			A29.2	177	Level crossing with many track
			A30	181	Falling rocks
			A31	182	Aircrafts flying at low altitude
			A32	183	Cross wind
			A33	189	Other dangers
			B1	211	Priority road
			B2	212	End of priority
			B3	221	Priority over oncoming
					traffic
			B4	222	Priority for oncoming traffic
			B5	231	Give way
			B6	232	Stop
			B7		Give way for cycles
			C1	311	Closed to all vehicles
			C2	312	No entry for power-driven vehicles
			C3	313	No entry for lorries
					and
					vans
			C4	314	No entry for vehicle combinations
			C5	315	No entry for tractors
			C6	316	No entry for motor cycles
			C7	317	No entry for snowmobile
			C8	318	No entry for vehicles carrying danger
					goods
			C9	319	No entry for buses
			C10	321	No entry for mopeds
			C11		No entry for cyclists
			C12	322	No entry for cycles or mopeds
			C13	323	No entry for pedestrians
			C14		No entry for cyclists
					or
					pedestrians
			C15	324	No entry for pedestri

			C16	325	ans cycles mopeds No entry for riders on horseback
			C17	331	No entry
			C18	332	No left turn
			C19	333	No right turn
			C20	334	No U turns
			C21	341	No entry for vehicles having an overall width
			C22	342	exceeding... Metres No entry for vehicles having an overall height exceeding...
			Me		tres
			C23	343	No entry for vehicles or
					combinations of vehicles exceeding ...metres
			C24	344	in length No entry for vehicles exceeding...tons laden mass
			C25	345	Maximum permissible
					total mass of combination of vehicles
			C26	346	No entry for vehicles having a mass exceeding... tons on one axle
			C27	347	Maximum permissible
					mass on bogie
			C28	351	Overtaking prohibited
			C29	352	End prohibition of
					taking
			C30	353	Overtaking prohibited by truck
			C31	354	End prohibition of
					taking by truck
			C32	361	Speed limit
			C33	362	End of speed limit
			C34	363	Speed limit zone
			C35	364	End of Speed limit
			zone		
			C36	365	Prohibition or restriction applying to one or more traffic lanes
			C37	371	Standing and parking prohibited
			C38	372	Parking prohibited
			C39	373	Parking prohibited
			zone		
			C40	374	End of parking prohibited zone
			C41	375	Taxi station zone (beginning)

			C42 taxi	376	Standing place for	
			C43		Loading place	
			C44.1 odd	381	Alternative parking	
			C44.2	382	days Alternative parking	
			C45	391	even days Passing without stop	
			C46	392	ping prohibited (cus toms control)	
			C47	393	ping without stop ping prohibited (po- lice control or other rea- son)	
			C48	393	Minimum distance be tween vehicles No entry for motor ve hicles with studded tyres	
			D1.1	411	Righ direction	
			D1.2	412	Left direction	
			D1.3	412	Straight direction	
			D1.4	413	Turn Right	
			D1.5	414	Turn left	
			D1.6	414	Straight direction or right turn	
			D1.7 left	415	Straight direction or turn	
			D1.8	415	Left turn or right turn	
			D1.9	416	Straight direction or right or left turn	
			D2	416	Compulsory rounda bout	
			D3.1	417	Pass right side	
			D3.2	417	Pass left side	
			D3.3	418	Divider of traffic	
			D4	421	Compulsory foot path	
			D5	422	Compulsory cycle	
			track	423	Combined cycle track and foot path	
			D6	423	Combined cycle track and foot path	
			D7.1 and	424	Parallel cycle track	
			on	424	foot path, cycle track	
			D7.2 and	425	left Parallel cycle track	
			on	425	foot path, cycle track	
			D8	426	right Compulsory track for snowmobiles	
			D9	427	Compulsory track for riders on horseback	
			D10 mum	427	Compulsory mini- mum	
			D11	427	speed End of Compulsory minimum speed	

			E1	511	Pedestrian crossing
			E2	512	Parking lot
			E3.1	520	Parking lot and access
					to train
			E3.2	520	Parking lot and access
					to bus
			E3.3	520	Parking lot and access
					to tram
			E3.4	520	Parking lot and access
					to subway
			E3.5	520	Parking lot and access
					to public transport
			E4.1	521 a	Parking directly
			E4.2	521 b	Parking opposite
					each
					other
			E4.3	521 c	Parking positioning at an angle
			E5	522	Meeting point
			E6	531-532	Bus stop for local and long distance traffic
			E7	533	Tram stop
			E8	534	Taxi station
			E9.1	541 a	Bus Lane
			E9.2	541 b	Bus and Taxi lane
			E10.1	542 a	Bus lane ends
			E10.2	5422 b	Bus and Taxi lane ends
			E11.1	5431	Tram lane
			E11.2	5432	Tram and Taxi lane
			E12.1	544 a	The tram lane ends
			E12.2	544 b	The tram and taxi lane ends
			E13.1		Cycle lane on the right
			E13.2		Cycle lane in the middle
			E14.1	551	One Way road
			E14.2		One Way road left right
			E15	561	Motorway
			E16	562	Motorway ends
			E17	563	Road for motor vehicles
			E18	564	Road for motor vehicles ends
			E19	565	Tunnel Sign
			E20	566	Tunnel Ends
			E21	567	Emergency stopping place
			E22	571	Built-up area
			E23	572	End of built-up area
			E24	573	Residential zone
			E25	574	End of residential zone
			E26	575	Pedestrian zone
			E27	576	End of pedestrian zone

			E28		Bicycle Street
			E29		Bicycle Street Ends
			E30		Traffic lanes merging
			F1.1	611	Advance direction
			sign		
			F1.2		Advance direction
			sign		
			F1.3		Advance direction
			sign		
			F2.1	612	Advance direction
			sign		
			F2.2		small
			sign		Advance direction
			F2.3		small
			sign		Advance direction
			F3		small
			sign		Advance direction
			F4.1	614	of traffic lanes
			tour		Advisory sign for de-
			F4.2	613	large
			F5	615	Advisory sign for de
			F6	616	tour
			F7.1	621	Detour
			F7.2	622	Route to be followed
			lanes		Information for traffic
			F7.3	6225	lanes
			F7.4		Bi-Directional infor
			F7.5		mation on traffic
			F7.6		lanes
			F8.1	623	Traffic lanes With Sep
			F8.2		arator
			F9		increased lane num-
			F10		ber
			sign		New lane incoming
			F11		New lane incoming
			sign		End of lane
			F12	633	End of lane
			F13	641,	Combined direction
			F14	643,	sign
			F15	648,	Advance direction
			tour	649	(above the lane)
			F16	642	Advance direction
			F17	646,	(above the lane)
			F18.1	647,	Exit sign (above the
				921	lane)
				644	Direction sign
				644a	
				650	Direction sign
					Exit sign
					Direction sign for de-
					tour
					Location sign
					Advance location sign
					Access Parking, Train

			F18.2		Access Parking, Bus
			F18.3		Access Parking, Tram
			F18.4		Access Parking, Sub way
			F18.5		Direction sign showing
					park-and-ride facilities
			F19	645	Direction sign for pedestrians
			F20.1	645	Direction Sign For Cyclists Without Distances
			F20.2	645	Direction Sign For
					cyclists With Distances
			F21.1		Advance Direction Sign For Cyclists With Distances
			F21.2		Advance Direction Sign For Cyclists Without Distances
			F22		Distance Board For Cyclists
			F23		Place Name For Cyclists
			F24.1	651	No Through Road
			F24.2	652	No Through Road Right/left
			F24.3		No Through Road
			F25	653	Recommended Maximum Speed
			F26	661	Sign Showing Distances
			F27.1	10, 11, 662	PlaceName
			F27.2		Waters Name
			F28	663	Road Number (E-road)
			F29	664	Road number (primary
					road)
			F30	665	Road number (secondary road)
			F31	665 a	Road Number (regional
					Road)
			F32	666	Road Number (ordinary
					Road)
			F33		Ring road number
			F34	6679	Interchange number
			F35	667	Direction To The Numbered Road
			F36		Substitute route
			F37	671	Symbol Of Motorway
			F38	672	Symbol of road for
					motor vehicles
			F39	673	Airport
			F40	674	Ferry

			F41		Cruise home port
			F42	675	Goods Harbour
			F43		Coods Terminal
			F44	676	Industrial Area
			F45		Shopping area
			F46.1	677	Parking
			F46.2	677 a	Parking Covered
			F47	678	Railway Station
			F48	679	Bus Station
			F49		Centre
			F50	681	Itinerary For Indicated Vehicle Category
			F50.1	6811	Truck route
			F50.2	6812	Passenger car route
			F50.3	6813	Bus route
			F50.4	6814	Van Route
			F50.5	6815	motorcycle Route
			F50.6	6816	Moped route
			F50.7	6817	Tractor route
			F50.8	6818	motorhome route
			F50.9	6819	Bicycle route
			F51	684	Itinerary For Dangerous
			F52	682	Goods Transport Itinerary For Pedestrians
			F53	683	Accesible route
			F54.1	685	Underpass With Steps
			F54.2		Overpass With Steps
			F55.1	686	Underpass Without Steps
			F55.2		Overpass Without Steps
			F55.3		Underpass For Wheel chair
			F55.4		Overpass For Wheel chair
			F56.1	690	Emergency exit on the left
			F56.2		Emergency exit on the right
			F57.1	691	Single exit route
			F57.2		Multiple exit route
			G1	701	Information sign for services
			G2	702	Information sign for services
			G3	703	Advance Information sign for services
			G4	704	Location Sign For services
			G5	704 a	Advance location sign for services
			G6	710	Radio Station Frequency
			G7	711	Information point
			G8	712	Information centre
			G9	715	FirstAid
			G10	721	Breakdown service
			G11.1	722	Filling Station
			G11.2		compressed natural gas Station

			G11.3		Charging Station
			G11.4		Hydrogen Filling Station
			G12	723	Hotel or motel
			G13	724	Restaurant
			G14	725	Cafeteria or refreshments
			G15	726	Public Lavatory
			G16	731	Youth hostel
			G17	733	Camping site
			G18	734	Caravan site
			G19	741	Picnic site
			G20	742	Outing site
			G21	791	emergency Phone
			G22	792	Extinguisher
			G23	772 a	Museum or historic building
			G24	772 b	World Heritage Site
			G25	772 c	Nature site
			G26	772 e	Viewpoint
			G27	772 f	Zoo
			G28	772 g	Other tourist attraction
			G29	773 a	Swimming Place
			G30	773 b	Fishing place
			G31	773 c	Ski lift
			G32		Cross-country skiing resort
			G33	773 d	Golf course
			G34	773 e	Pleasure or theme park
			G35	774 a	Cottage accommodation
			G36	774 b	Bed and breakfast
			G37	774 c	Direct sale
			G38	774 d	Handicrafts
			G39	774 e	Farm park
			G40	774 f	Horseback riding
			G41.1	771 a	Tourist route text only
			G41.2	771 b	Tourist route
			G42		Temporary guidance sign
			I1		Barrier
			I2.1		Fence
			I2.2		Fence With arrows
			I3.1		Barrier on the left
			I3.2		Barrier on the right
			I3.3		VerticalBarrier
			I4		traffic cone
			I5		direction to avoid obstacle
			I6	916	Curve direction sign
			I7.1	931	Border mark on the left
			I7.2	931	Border mark on the right
			I8	935	Height Border
			I9	941	underpass height
			I10.1	932	Traffic sign column, blue and white
			I10.2		Traffic sign column, yellow and black
			I11	911	diverging road sign

			112.1 112.2 113 114 Board 115 116 117.1 area 117.2 area 118 mation 119		Edge pole on the left Edge pole on the right tow away zone SOS Information 9901 Automatic traffic control surveillance camera 9512 Reindeer herding 9512 Reindeer herding without text 9512 Speed limit information country border
Additional plate type	code value	Traffic sign code value	New	Old	
<ul style="list-style-type: none"> • Legal number 729/2018 (New) • Old regulation (old) 			H1 H2.1 H2.2 H2.3 H3 H4 H5 H6 H7 H8 H9.1 H9.2 H10 H11 H12.1 H12.2 H12.3 H12.4 H12.5 H12.6 H12.7 H12.8	811 812 813 814 815 816 821 822 823 824 825 826, 827 828 831 832 833 834 835 836 841	Sign to crossing road Sign applies in the direction of the arrow Sign applies in the direction of the arrow with distance Sign applies in the direction of the arrow with distance Distance to which the sign applies Distance from the sign to the point to which the sign applies Distance to the compulsory stop Free width Free Height Height Electric Line Sign Applies Both Directions SignApplies Both Directions Vertical Sign applies to the direction of the arrow Sign applies to...area ends Passenger Car Bus Lorry Van Husvagn Caravan motorhome Vehicle For Handicapped MotorCycle Moped

			H12.9	842	Cycle
			H12.10	843	Snowmobile
			H12.11		Tractor
			H12.12		Low emission vehicle
			H12.13		Parking on top of curb
			H13.1	845	Parking on the edge of the
			H13.2	844	curb
			H14	848	No entry for vehicles carrying
			H15	849	dangerous goods of group A
			H16		No entry for vehicles carrying
					dangerous goods of group B
					Tunnel class
			H17.1	851	Sign applies between Mo-Fr
			H17.2	852	Sign applies on Saturdays
			H17.3	853	Sign applies on Sundays and
			H18	854	holidays
			H19.1	856a	Time Limit
			H19.2	856b	Obligatory Use Of Parking
			H20		Disc
			855a,		Obligatory Use Of Parking
					Disc
					Parking Against Fee
				855b	Charging point / Charging
			H21		place
					Direction Of Priority Road
			H22.1	861,	DirectionOfPriorityRoad
				861a	Two-way cycle track
			H22.2	861	Two-way cycle track
			b		Additional Panel With Text
			H23.1	863	Driving in service purposes
			H23.2		allowed
			H24	871	Emergency Phone And Extinguisher
			H25	872	
			H26	880	

4.3.7 Railway crossing

Definition

Railway crossing includes:

- a name
- type of safety device
- A level crossing symbol that can be used to connect to a track information system

Coverage

Information applies to roads, streets and some private roads.

Link to the Railway crossing table

[Rautatien tasonisteys](#)

RAILWAY CROSSING	
Type of safety device	Code value
Railway not in use	1
No safety device	2
Only light and/or sound signal	3
Half barrier and possible light and/or sound signal	4
Full barrier and possible light and/or sound signal	5

4.4 Line Attribute data

4.4.1 Speed limit

Definition

The maximum vehicle speed assigned to a route.

Values

Arvo (value) field indicates the speed limit value (km/h). Speed limit 90 km/h is only used in Åland.

Coverage

Speed limit applies to all road links excluding pedestrian and cycle paths and vehicle tracks. If the administrator has not updated the road link speed limit, an empty speed limit with null value is generated for the link. The null speed limit does not have an ID.

Link to the Speed limit table

[Speed Limit](#)

SPEED LIMIT			
Attribute data	Data type	Description	Code values
Validity direction	Code value	Validity direction in relation to the direction of digitisation of a road link.	1 Both directions 2 In the direction of digitisation 3 Against the direction of digitisation

4.4.2 Maximum allowed ... x 7

Maximum allowed restrictions are:

- Maximum weight allowed for a vehicle
- Maximum weight allowed for an articulated vehicle

- *Maximum weight per axle allowed for a vehicle*
- *Maximum weight per tandem-axle allowed for a vehicle*
- *Maximum height allowed for a vehicle*
- *Maximum length allowed for a vehicle or articulated vehicle*
- *Maximum width allowed for a vehicle*

Definition

The 'maximum allowed...' attribute data are line attribute data that cover all the area, where the restriction is valid. The weight restrictions are indicated with an accuracy of 100 kilograms and the height, length and width restrictions as centimetres. For roads, height restrictions below 440 cm are indicated. The unit of weight restrictions is kg and the unit of height, length and width restrictions is cm.

Values

Arvo (value) field indicates the value of the restriction (kg or cm).

Coverage

Information applies to roads, streets and some private roads. The information is to be saved for all the area, where the restriction is valid.

Link to the Maximum allowed... table

*Maximum weight allowed for a vehicle
Maximum weight allowed for an articulated vehicle
Maximum weight per axle allowed for a vehicle
Maximum weight per tandem-axle allowed for a vehicle
Maximum height allowed for a vehicle
Maximum length allowed for a vehicle or articulated vehicle
Maximum width allowed for a vehicle*

4.4.3 Lit road

Definition

The road has lighting. Lit road is line attribute data which may apply to the whole link or only to a part of it.

Coverage

Information applies mainly to roads and streets.

Link to Lit road table

[Lit road](#)

4.4.4 Paved road

Definition

All pavement types are classified as pavements. There is no pavement segment on the part of road network covered with gravel. Nearly always the pavement information covers the whole link. The data source for all road links is the topographic database of The National Land Survey of Finland

Coverage

Information applies to all route types.

Link to Paved road table

[Paved road](#)

PÄÄLYSTETTY TIE			
Attribute name	Data type	Description	Code values
Class	Code value	Describes the pavement type of the road.	1 Concrete 2 Stone 10 Hard asphalt concrete 20 Pehmeät asfalttibetonit 20 Soft asphalt concrete 30 Gravel surface 40 Gravel wear layer 50 Other coatings 99 Paved, type unknown

4.4.5 Road affected by thawing

Definition

Road affected by thawing is the part of the traffic network that tends to suffer from thawings. A temporary weight restriction may be in force on the road during a thawing.

Values

Arvo (value) field indicates the maximum load-bearing capacity (kg) of road damaged by thawing.

Coverage

Information applies mainly to main roads and to private roads..

Link to Road affected by thawing table

Road_thawing

4.4.6 Width

Definition

Road width is the width of the part of the carriageway meant for vehicle traffic. On paved roads the carriageway is often separated from the shoulders with a white border line. If a border line doesn't exist, the width equals the width of the paving. On gravel roads the width equals the width of the whole road, since gravel roads don't have shoulders.

Values

Arvo (value) field indicates the value of the width (cm).

Coverage

Information is available for all road links except driving path, walking and cycling paths and ferrys.

Link to Width table

Width

4.4.7 Road work

Definition

Road work includes targets in which road works are being carried out. Road links can be either partially or fully broken. An estimation of the starting and ending date should be reported. Also road work ID can be notified.

Coverage

Road work information are currently only on street network.

Link to Road work table

Traffic volume

4.4.8 Parking restriction

Definition

Parking restriction is linear data which indicates areas where parking / stop-ping are forbidden. You can also report an estimation of the starting and end -ing date. Targets are also derived from traffic signs that indicate parking re- striction.

Coverage

Mainly on street network

Link to Parking restriction table

Parking restriction

PARKING RE- STRICTION			
Attribute data	Data type	Description	Code values
Class	Code values	Describes road treatment class	1 Stopping forbidden 2 Parking forbidden

4.4.9 Road treatment class

Definition

Treatment class is linear road data. Roads and streets have their own winter-treatment classes. Winter treatmentclass classifications are based on the Finnish Road Registry (Tierekisteri). The streets have a three-tier classifica- tion for road- ways and walking and cycling routes. There are no treatment classes for private roads.

Coverage

Mainly on street network

Link to Parking restriction table

[Treatment class](#)

Treatment class			
Attribute data	Data type	Description	Code values
Treatmentclass	Code values	Describes road treatment class	
		State roadways (highways)	1 Anti-slip without operating time 2 Normally always exposed 3 Normally exposed 4 Mostly salted, occasionally slightly slippery 5 Mainly sandable, thin snow is allowed 6 Mostly snowy 7 Mostly snowy, longest operating time
		State walking and cycling lanes	8 Light traffic quality lanes 9 Fairly busy light traffic lanes 10 Basic winter care level for light traffic lanes 11 Light traffic lanes with no winter care
		Municipal carriageways (streets)	20 Class I (Main streets and busy fairways) 30 Class II (Collector streets) 40 Class III (Pkot streets)
		Municipal walking and cycling routes	50 Class A 60 Class B 70 Class C

4.4.10 Private roads with road associations

Definition

This level shows all the private roads with road associations. The information is stored with the accuracy of the road link, which allows it to generalize the location of private roads in the city. For more information, see if the municipality has submitted a private road announcement to Digiroad for the road and whether weight- and / or vehicle-specific restrictions have been submitted to the road. The name of the road association will not be published.

Coverage

All the private roads in Finland

Link to Parking restriction table

[Private roads with road associations](#)

Private roads with road associations			
Attribute data	Data type	Description	Code values
Additional information	Code value	Restrictions on a road	Not delivered Delivered restrictions Delivered no restriction

4.4.11 Traffic volume

Definition

Traffic volume is the average number of vehicles passing per day. If the road that consists of one carriageway is split into two carriageways, both carriageways get the same traffic volume value that existed for the road before the splitting.

Values

Arvo (value) field indicates the traffic volume (vehicles per day).

Coverage

Information applies to roads and partially to the road network. From publication 3/2017 the information is produced directly from FTA road register. The inventory information is updated once a year and it is based on measurements made during the previous fall.

Link to Road work table

Traffic volume

4.4.12 Vehicle-specific restriction

Definition

A part of the road network where driving with a certain vehicle type(s) is prohibited by traffic signs. Validity period can be given by a vehicle specific restriction. The vehicles that are not covered by the restriction can be added as exceptions to the vehicle, motor vehicle and passage through restrictions.

In Digiroad, the vehicle specific restrictions which the Road Traffic Act imposes or which are indicated by the selection of the road link type are not maintained on motorways and other corresponding road types (including semi-motorway, pedestrian and cycle path).

If one position includes several prohibited vehicle types, objects that overlap by geometry are formed to the R and K releases of Digiroad. These objects have the same restriction ID, position information and last edited time data.

Coverage

Information applies mainly to roads, streets and private roads.

Link to Vehicle specific restriction table

[Vehicle specific restriction](#)

VEHICLE SPECIFIC RESTRICTION			
Attribute data	Data type	Description	Code values
Validity direction	Code value	Validity direction in relation to the direction of digitisation of a road link.	1 Both directions 2 In the direction of digitisation 3 Against the direction of digitisation

Type of prohibited vehicle	Code value	Type of prohibited vehicle	2 Motor vehicle 3 Vehicle 4 Truck 5 Bus 6 Delivery vehicle 7 Passenger car 8 Taxi 9 Motorcycle 10 Moped 11 Cycle 12 Pedestrian 13 Articulated vehicle 14 Tractor or farm vehicle 15 Car with trailer / recreational vehicle 19 Military vehicle 21 Driving in service purposes 22 Driving to a lot 23 Passage through 26 Horse riding 27 Snow mobile 28 Special transport
Validity period	Character string	Validity period of the restriction, time domain	
Exceptions	Code value	Vehicle types not covered by the restriction. Exceptions can apply to restrictions of vehicle, motor vehicle and passage through.	Same code values as in the type of prohibited vehicle.

4.4.13 Restriction for the transportation of dangerous goods (VAK)

Definition

A part of the road network where the transportation of dangerous goods (VAK) is prohibited.

The value of VAK restriction can be A-VAK or B-VAK which is shown in a plate of the restriction sign.

If the restriction includes both A-VAK and B-VAK, they will be formed as geo-metrically overlapping objects to the R and K releases of Digiroad. A-VAK and B-VAK are never valid simultaneously, so the overlapping objects have always a period of validity for the restriction. These objects have the same restriction ID, position information and last edited time data.

Coverage

Information applies to roads and streets.

Link to Restriction for the transportation of dangerous goods table

[Restriction for the transportation of dangerous goods](#)

RESTRICTION FOR THE TRANSPORTATION OF DANGEROUS GOODS (VAK)		
Attribute data	Data type	Description
Validity direction	Code value	Validity direction in relation to the direction of digitisation of a road link. 1 Both directions

		2 In the direction of digitisation 3 Against the direction of digitisation
Type of prohibited vehicle	Code value	24 A-VAK 25 B-VAK
Validity period	Character string	Validity period of the restriction, time domain

4.4.14 Number of lanes

Definition

Information on the number of lanes is given according to the direction when there is more than one lane in a particular direction on one carriageway roads, and more than two lanes on two carriageway roads. Diverging lanes on the junctions are not included.

In the following cases, there is no information on the number of lanes in Digiroad:

- one-way road with one carriageway: 1 lane (one lane in the direction of the traffic flow)
- two-way road with one carriageway: 1+1 lanes (one lane in the direction of the traffic flow)
- two-way road with two carriageways: 2+2 lanes (two lanes in the direction of the traffic flow)

Example 1: In a one carriageway road at the point where there is a passing/fast lane in the direction of the digitisation, the validity direction is 2 and the number of lanes 2.

Example 2: In a one carriageway road at the point where there are passing/fast lanes to both directions, the validity direction is 1 and the number of lanes 2.

Coverage

Information applies to roads and streets.

Link to Number of lanes table

[Number of Lanes](#)

NUMBER OF LANES		
Attribute data	Data type	Description
Validity direction	Code value	Validity direction in relation to the direction of digitisation of a road link. 1 Both directions 2 In the direction of the digitisation 3 Against the direction of digitisation
Number of lanes	Numerical	Number of lanes according to the direction (>1)

4.4.15 Public transport lane

Definition

A road with a public transport lane.

Coverage

Information applies to roads and streets.

Link to Public transport lane table[Public transport lane](#)

Public transport lane		
Attribute data	Data type	Description
Validity direction	Code value	Validity direction in relation to the direction of digitisation of a road link. 1 Both directions 2 In the direction of the digitisation 3 Against the direction of digitisation

4.4.16 E-road number

Definition

E-road number are of the form E+<number>. One road can have many E-road numbers.

If a road has two or more E-road numbers, they are listed in R and K releases of Digiroad and separated from each other by a comma.

Coverage

Information applies to roads and in few cities also to streets.

Link to E-Road number table[E-Road number](#)

4.4.17 Exit number

Definition

Exit numbers are numbers given to ramps on motorways or semi-motorways. Exit numbers can consist of both a number and a letter, for example exit numbers 9A and 9B in Vantaankoski.

If one road has two or more exit numbers, they are listed in R and K releases of Digiroad and separated from each other by a comma.

Coverage

Information applies to the motorway and semi-motorway ramps (on the roads).

Link to Exit number table[Exit number](#)

4.4.18 Winter speed limit

Definition

Speed limit during winter data is based on decisions made by local road authorities (ELY) in autumn 2016. Speed limits during winter is no longer applied on the road segments (in the intersections) where regular speed limit is lower than speed limit during winter.

Values

Arvo (value) field indicates the value of the winter speed limit (km/h).

Coverage

Information applies to roads.

Link to Winter speed limit

[Winter speed limit](#)

4.5 Other features

4.5.1 Service

Definition

Service means the kind of service that helps and supports the users of traffic network, e.g. a parking building or bus station. Service has a point geometry (service point) which is located at the point where the service exists (in the middle/centre point of a building or property), not on a road link. One service point may have many services.

If one service point has many services, objects that overlap the geometry are formed to the shapefiles of the R and K releases of Digiroad. These overlap - ping objects have the same service point ID, position information and last edited time.

Coverage

The coverage of data varies according to the service.

Link to Service table

[Service](#)

Service		
Attribute data	Data type	Description
Service point ID	Numerical	The ID identifying the service point
Service ID	Numerical	The ID identifying the service
Service type	Code value	The type of the service
Specifier of the rest area	Code value	The type of the rest area on rest areas or lay-bys, parking areas and bus and truck parking areas
Type of railway station	Code value	
Name of service	Character string	
Number of parking spaces	Numerical	Number of parking spaces on parking areas and houses
Additional information of the service	Character string	

Type of service		
Type of service	Code value	Description
Customs	4	
Frontier crossing	5	

Rest area (or lay-by)	6	Rest area, petrol station, kiosk, cafeteria, restaurant or accommodation services.
Airport	8	An airport which accommodates either cargo or passenger traffic of a commercial or private nature.
Ferry terminal	9	The access point or check-in area for a ferry company.
Taxi stand	10	
Railway station	11	
Parking lot	12	Parking lot which has at least 40–50 public parking spaces. There may be a charge for parking but there may not be other restrictions (e.g. parking only allowed for customers of a particular store). In addition, parking lot object can also include more accurate information about facilities.
Car shipping terminal	13	A location where cars may be loaded onto trains or ferries.
Coach and lorry parking (area / lot)	14	
Parking house/building	15	Parking house/building which has at least 40–50 public parking spaces. There may be a charge for parking but there may not be other restrictions (e.g. parking only allowed for customers of a particular store).
Bus station	16	
Drum tube	19	

Type of rest area		
Type of rest area	Code value	Description
Rest area, comprehensive facilities	1	Comprehensive facilities include other facilities and services in addition to the basic ones
Rest area, basic facilities	2	Basic facilities include the following facilities or services: - parking area - waste container - toilets - table and bench
Private service area	3	Privately run service area has e.g. a petrol station, kiosk, cafeteria, restaurant or accommodation services.
No data	4	
Important railway station	5	Passenger transport station, where possibly also freight traffic
Less important railway station	6	Not necessarily passenger traffic
Underground/metro station	7	

5 Appendices

Appendix 1

[Description of data content - field names, data types and code values](#)

Appendix 2

[Public transport stop facility data and other attribute data](#)

Appendix 3

[Primary data sources by data objects](#)

Appendix 4

[Time domain character string](#)

5.1 Appendix 1. Description of data content - field names, data types and code values

Road line

Line

Description	Field (shape)/ Element (WFS)	Data type (shape)	Additional information
Link breakpoints	<i>shape/ points</i>	<i>geometry (polylineZm)</i>	<i>X and Y coordinates: ETRS-TM35FIN Z coordinate: N60 M value: metre (X,Y level)</i>
Link ID	<i>LINK_ID</i>	<i>text, 20</i>	
ID (by the National Land Survey)*	<i>LINK_MML_ID</i>	<i>text, 20</i>	
Administrative class	<i>HALLINN_LK</i>	<i>integer</i>	<i>code value</i>
Functional class	<i>TOIMINN_LK</i>	<i>integer</i>	<i>code value</i>
Direction of traffic flow	<i>AJOSUUNTA</i>	<i>integer</i>	<i>code value</i>
Link type	<i>LINKKITYYP</i>	<i>integer</i>	<i>code value</i>
Bridge, underpass or tunnel	<i>SILTA_ALIK</i>	<i>integer</i>	<i>code value</i>
Link phase	<i>LINK_TILA</i>	<i>integer</i>	<i>code value (to be published later)</i>
Name of road or street in Finnish	<i>TIENIMI_SU</i>	<i>text, 200</i>	
Name of road or street in Swedish	<i>TIENIMI_RU</i>	<i>text, 200</i>	
Name of road or street in Sami	<i>TIENIMI_SA</i>	<i>text, 200</i>	
Address first house on the left	<i>ENS_TALO_V</i>	<i>integer</i>	
Address first house on the right	<i>ENS_TALO_O</i>	<i>integer</i>	
Address last house on the left	<i>VIIM_TAL_V</i>	<i>integer</i>	
Address last house on the right	<i>VIIM_TAL_O</i>	<i>integer</i>	
Municipality code	<i>KUNTAKOODI</i>	<i>integer</i>	
Road number	<i>TIENUMERO</i>	<i>integer</i>	
Number of the part of a road	<i>TIEOSANRO</i>	<i>integer</i>	
Carriageway	<i>AJORATA</i>	<i>integer</i>	<i>code value</i>
Start measure from the beginning of the road part	<i>AET</i>	<i>integer</i>	
End measure from the beginning of road part	<i>LET</i>	<i>integer</i>	
Horizontal accuracy	<i>SIJ_TARK</i>	<i>integer</i>	<i>code value</i>
Vertical accuracy	<i>KOR_TARK</i>	<i>integer</i>	<i>code value</i>

Digitisation direction in relation to the geometry of National Land Survey of Finland	GEOM_FLIP	integer	code value
Start M value	ALKU_PAALU	double	
End M value	LOPP_PAALU	double	
Last edited	MUOKKAUSPV	text, 20	time stamp "12.06.2014 13:29:17"
Source geometry	GEOM_LAHDE	integer	code value
Road classification according to the topographic database (National Land Survey)	MTK_TIE_LK	integer	code value, explanations can be found in the description by the National Land Survey
Road address growth direction	TIEN_KASVU	integer	Code value

* If the link does not have a MML-ID, this means that its' source is some other than the National Land Survey.

Name	Code value	Description
Administrative class	1	Road owned by the state
	2	Road owned by a municipality
	3	Road owned privately, e.g. by a road association
	99	No data
Functional class	1	Class I main road or regional main street
	2	Class II main road or regional main street
	3	Regional road or local main street
	4	Connecting road or collector street
	5	Feeder street or class I private road
	6	Class II private road
	7	Vehicle track
	8	Walking and cycling path
	99	No data (Only road links under construction)
Direction of traffic flow	2	Traffic is permitted in both directions
	3	Traffic is permitted against the direction of digitisation
	4	Traffic is permitted in the direction of digitisation
Link type	1	Part of a motorway
	2	Part of a multiple carriageway, which is not a motorway
	3	Part of single carriageway
	4	Part of a semi-motorway
	5	Part of a roundabout
	6	Slip road
	7	Rest area
	8	Cycling path or combined walking and cycling path
	9	Part of a pedestrian zone, e.g. a pedestrian street or footpath

	10	Part of a service or emergency road
	11	Enclosed traffic area
	12	Vehicle track, roads accessible by off-road vehicles
	13	Service access point on a motorway
	14	Route for special deliveries without a locked barrier structure
	15	Route for special deliveries with a locked barrier structure
	21	Ferry/cable ferry
	99	No data (Only road links under construction)
Bridge, underpass or tunnel	-11	Tunnel
	-3	Underground
	-2	Underground
	-1	Underpass
	0	At ground level
	1	Bridge, level 1
	2	Bridge, level 2
	3	Bridge, level 3
	4	Bridge, level 4
Link phase	Null	Valid
	1	Under construction
	3	Planned
Carriageway	1	First carriageway on the right in the direction of the road number
	2	Second carriageway on the right in the direction of the road number
	0	Single carriageway road
Accuracy for the geometries	0	Not defined
	500	0,5 m
	800	0,8 m
	1000	1 m
	2000	2 m
	3000	3 m
	4000	4 m
	5000	7 m
	7500	7,5 m
	8000	8 m
	10000	10 m
	12500	12,5 m
	15000	15 m
	20000	20 m
	25000	25 m

	30000	30 m
	40000	40 m
	80000	80 m
	100000	100 m
Vertical accuracy	1	Not defined
	201	KM (EM) (traced from the 2 m resolution model)
	500	0,5 m
	800	0,8 m
	1000	1 m
	2000	2 m
	3000	3 m
	4000	4 m
	5000	5 m
	7500	7,5 m
	8000	8 m
	10000	10 m
	12500	12,5 m
	15000	15 m
	20000	20 m
	25000	25 m
	30000	30 m
	40000	40 m
	80000	80 m
	100000	100 m
	100001	KM (EM) 10 m (traced from the 10 m resolution model)
	250001	KM 25 m (traced from the 25 m resolution model)
Digitisation direction in relation with the geometry of National Land Survey of Finland	0	Direction of digitization remained the same
	1	Changed direction of digitisation
Source geometry	1	National Land Survey
	2	other, not specified

Restricted manoeuvre

Relationship between the links

Restricted manoeuvre information is complementary data for road links. Its utilization requires that the road link material/data is in use. For visualization, the geometry for the restricted manoeuvre has been formed in the release from the geometry of the source and object links.

Description	Field (shape)/ Element (WFS)	Data type (shape)	Additional information
ID	ID	text, 20	
Position	shape/ points	geometry (polylineZ)	ETRS-TM35FIN, formed from the source and object link geometry
Source link ID	LAHD_ID	text, 20	
Object link ID	KOHD_ID	text, 20	
Vehicles not covered by restricted manoeuvre	POIKKEUS	text, 40	comma-separated list of vehicle types
Validity period	VOIM_AIKA	text, 200	time domain
Additional information	LISATIEDOT	text, 200	
Last edited	MUOKKAUSPV	text, 50	time stamp "12.6.2014 13:29:17"
Municipality code	KUNTAKOODI	integer	

Name	Code value	Description
Vehicle type	4	Truck
	5	Bus
	6	Van
	7	Passenger car
	8	Taxi
	9	Motorcycle
	10	Moped
	13	Articulated vehicle
	14	Tractor or farm vehicle
	15	Car with trailer/ recreational vehicle
	19	Military vehicle
	21	Driving in service purposes
	22	Driving to a lot
	27	Snow mobile

Restricted manoeuvre_link (Digiroad R delivery mode only)

Selite	Kenttä (dbf)	Tietotyyppi (dbf)	Lisätieto
ID	ID	text, 20	
Restricted manoeuvre ID	KAANRAJ_ID	text, 20	
Link-ID	LINK_ID	text, 20	
Status	STATUS	integer	
Serial number in Restricted manoeuvre	JARJES_NRO	integer	The order difference of the start (source) link is zero.
Municipal code	KUNTAKOODI	integer	
Nimi	Koodiarvo	Selite	
Status	1	start (source) link	
	2	intermediate link	
	3	end (destination) link	

Public transport stop

Point

Description	Field (shape)/ Element (WFS)	Data type (shape)	Additional information
National ID	VALTAK_ID	integer	
Position	shape/point	geometry (pointZ)	ETRS-TM35FIN
Coordinate X	KOORD_X	double	ETRS-TM35FIN
Coordinate Y	KOORD_Y	double	ETRS-TM35FIN
Link ID	LINK_ID	text, 20	
Sijainti linkillä	SIJAINTL_M	double	M value: metre (x, y level)
Validity direction	VAIK_SUUNT	integer	code value
Name in Finnish	NIMI_SU	text, 200	
Name in Swedish	NIMI_RU	text, 200	
Data administrator	YLLAPITAJA	integer	code value
Administrator identifier	YLLAP_TUNN	text, 50	
Livi identifier	LIVI_TUNN	text, 50	
Traveller identifier	MATK_TUNN	text, 50	
Ground coordinate X	MAAST_X	text, 50	
Ground coordinate Y	MAAST_Y	text, 50	

Ground coordinate Z	MAAST_Z	text, 50	
Direction of travel	LIIK_SUUNTA	text, 200	
Traffic bearing	L_SUUNTIMA	integer	degree 0-360
Valid from date	ENS_VO_PV	text, 50	time stamp "12.06.2014"
Valid to date	VIIM_VO_PV	text, 50	time stamp "12.06.2014"
Stop type	PYS_TYYPPI	text, 20	comma-separated list of types, no square brackets
Timetable	AIKATAULU	integer	code value
Shelter	KATOS	integer	code value
Bench	PENKKI	integer	code value
Advertising shelter	MAINOSKAT	integer	code value
Cycle rack	PYORATELIN	integer	code value
Electronic timetable board	S_AIKATAUL	integer	code value
Lighting	VALAISTUS	integer	code value
Accessibility to persons with reduced mobility	ESTETTOMYY	text, 200	
Possibility to escort by car	SAATTOMAHD	integer	code value
Number of park-and-ride places	LIIT_LKM	text, 200	
Additional information on park-and-ride facilities	LIIT_LISAT	text, 200	
Stop owner	PYS_OMIST	text, 200	
Feedback address	PALAUTE_OS	text, 200	
Additional information	LISATIEDOT	text, 200	
Disconnected from geometry	IRTI_GEOM	integer	code value
Last edited	MUOKKAUSPV	text, 50	time stamp "12.06.2014 13:29:17"
Municipality code	KUNTAKOODI	integer	
Service class	PALVELUTASOLUOKKA	integer	

Name	Code value	Description
Data administrator	1	Municipality
	2	Centre for Economic Development, Transport and the Environment
	3	Helsinki Regional Transport
	99	Unknown
Validity direction	2	In the direction of digitisation
	3	Against the direction of digitisation
Stop type	1	Tram
	2	Local transport
	3	Long-distance transport

	4	<i>Express</i>
	5	<i>Virtual stop</i>
	6	<i>Terminal</i>
	99	<i>No data</i>
<i>Disconnected from geometry</i>	1	<i>Connected to geometry</i>
	2	<i>Disconnected from geometry</i>
<i>Timetable</i>	1	<i>No</i>
	2	<i>Yes</i>
	99	<i>No data</i>
<i>Shelter</i>	1	<i>No</i>
	2	<i>Yes</i>
	99	<i>No data</i>
<i>Advertising shelter</i>	1	<i>No</i>
	2	<i>Yes</i>
	99	<i>No data</i>
<i>Bench</i>	1	<i>No</i>
	2	<i>Yes</i>
	99	<i>No data</i>
<i>Cycle rack</i>	1	<i>No</i>
	2	<i>Yes</i>
	99	<i>No data</i>
<i>Electronic timetable board</i>	1	<i>No</i>
	2	<i>Yes</i>
	99	<i>No data</i>
<i>Lighting</i>	1	<i>No</i>
	2	<i>Yes</i>
	99	<i>No data</i>
<i>Possibility to escort by car</i>	1	<i>No</i>
	2	<i>Yes</i>
	99	<i>No data</i>
<i>Service type class</i>	1	<i>Terminal</i>
	2	<i>Central knot stop</i>
	3	<i>Lively stop</i>
	4	<i>Basic stop</i>
	5	<i>Little used stop</i>
	6	<i>Leaving stop</i>
	7	<i>Virtual stop</i>

	8	<i>Stops not used for bus services</i>
	99	<i>No data</i>

Barrier

Point

Description	Field (shape)/ Element (WFS)	Data type (shape)	Additional information
ID	<i>ID</i>	<i>text, 20</i>	
Position	<i>shape/ point</i>	<i>geometry (pointZ)</i>	<i>ETRS-TM35FIN</i>
Link ID	<i>LINK_ID</i>	<i>text, 20</i>	
Distance from the start of the link	<i>SIJAINTI_M</i>	<i>double</i>	
Barrier type	<i>EST_TYYPPI</i>	<i>integer</i>	<i>code value</i>
Last edited	<i>MUOKKAUSPV</i>	<i>text, 50</i>	<i>time stamp "12.06.2014 13:29:17"</i>
Municipality code	<i>KUNTAKOODI</i>	<i>integer</i>	

Name	Code value	Description
Barrier type	1	<i>Blocked passage</i>
	2	<i>Traffic barrier gate which can be opened</i>

Traffic light

Point

Description	Field (shape)/ Element (WFS)	Data type (shape)	Additional information
ID	<i>ID</i>	<i>text, 20</i>	
Position	<i>shape/ point</i>	<i>geometry (pointZ)</i>	<i>ETRS-TM35FIN</i>
Link ID	<i>LINK_ID</i>	<i>text, 20</i>	
Distance from the start of the link	<i>SIJAINTI_M</i>	<i>double</i>	
Last edited	<i>MUOKKAUSPV</i>	<i>text, 50</i>	<i>time stamp "12.06.2014 13:29:17"</i>
Municipality code	<i>KUNTAKOODI</i>	<i>integer</i>	

Pedestrian crossing

Point

Description	Field (shape)/ Element (WFS)	Data type (shape)	Additional information
ID	<i>ID</i>	<i>text, 20</i>	
Position	<i>shape/ point</i>	<i>geometry (pointZ)</i>	<i>ETRS-TM35FIN</i>
Link ID	<i>LINK_ID</i>	<i>text, 20</i>	
Distance from the start of the link	<i>SIJAINTI_M</i>	<i>double</i>	
Last edited	<i>MUOKKAUSPV</i>	<i>text, 50</i>	<i>time stamp "12.06.2014 13:29:17"</i>
Municipality code	<i>KUNTAKOODI</i>	<i>integer</i>	

Directional traffic sign

Point

Description	Field (shape)/ Element (WFS)	Data type (shape)	Additional information
ID	ID	text, 20	
Sijainti	shape/ point	geometry (pointZ)	ETRS-TM35FIN
Link ID	LINK_ID	text, 20	
Distance from the start of the link	SIJAINTI_M	double	
Validity direction	VAIK_SUUNT	integer	code value
Bearing	SUUNTIMA	integer	degree
Text	TEKSTI	text, 200	comma-separated list of texts
Last edited	MUOKKAUSPV	text, 50	time stamp "12.06.2014 13:29:17"
Municipality code	KUNTAKOODI	integer	

Name	Code value	Selite
Validity direction	2	In the direction of digitisation
	3	Against the direction of digitisation

Traffic sign

Point

Description	Field (shape)/ Element (WFS)	Data (shape)	Additional information
ID	ID	text, 20	
Position	shape/point	geometry (pointZ)	ETRS-TM35FIN
Link ID	LINK_ID	text, 20	
Distance from the start of the link	SIJAINTI_M	double	
Value	ARVO	integer	Code value
Type of traffic sign	TYYPPI	integer	Code value for the traffic sign type
Additional info for the traffic sign	LISATIEDOT	text, 200	Additional info for the traffic sign as text
Terrain coordinate X	MAASTO_X	integer	Road sign terrain coordinate X
Terrain coordinate Y	MAASTO_Y	integer	Road sign terrain coordinate Y
First day of validity	ENS_VO_PV	text 50	
Last day of validity	VIIM_VO_PV	text 50	

Traffic sign status	TILA	integer	
Main traffic sign text	PAAMERKTXT	text 50	Added text for main traffic sign
Road name	TIEN_NIMI	text 50	
Location specification	SIJAJINTITR	integer	Location specification of the traffic sign as a code value
Type of damage	VAURIOTYYPI	integer	Traffic sign damage type as a code value
Old traffic sign code	VANHAKOODI	integer	Type code of the traffic sign according to the old road traffic law, information only with traffic signs according to the old regulation
Size	KOKO	integer	Traffic sign size as a code value
Height	KORKEUS	integer	The height of the lower edge of the traffic sign from the road surface cm
Lane	KAISTA	integer	Lane number where the traffic sign is located koo-diarvo (lane maintenance has not yet started in Digiroad, so it is not yet possible to give lane numbers to traffic signs)
Lane type	KAISTATYYP	integer	The type of lane on which the traffic sign is located (lane maintenance has not yet started on Digiroad, so road signs cannot yet be given a lane type)
Structure	RAKENNE	integer	Additional information about the character structure as a code value
Condition	KUNTO	integer	Code value describing the condition of the traffic sign
Film type	KALVONTYYP	integer	Road sign film type code value
Urgency of repair	KORJKIIRE	integer	Code value of the urgency of road sign correction
Estimated service life	ARVKAYTIKA	integer	Estimated service life of the road sign in years
Additional panel 1 type	KILPITYYP1	integer	Additional panel 1 code type
Additional panel 1 value	KILPIARVO1	integer	Additional panel 1 value
Additional panel 1 info	KILPIINFO1	text, 50	Additional panel 1 info
Additional panel 1 text	KILPI_TXT0	text 50	Additional panel 1
Additional panel 1 size	KILPIKOKO1	integer	Additional panel 1 size as code value
Additional panel 1 film	KILPIKALV1	integer	Additional panel 1 film type
Additional panel 1 colour	KILPIVARI1	integer	Additional panel 1 colour as code value
Additional panel 2 type	KILPITYYP2	integer	Additional panel 2 type as code value
Additional panel 2 value	KILPIARVO2	integer	Additional panel 2 value
Additional panel 2 info	KILPIINFO2	text, 50	Additional panel 2 info

Additional panel 2 text	KILPL_TXT1	text 50	
Additional panel 2 size	KILPIKOKO2	integer	Additional panel 2 size as code value
Additional panel 2 film	KILPIKALV2	integer	Additional panel 2 film type
Additional panel 2 colour	KILPIVARI2	integer	Additional panel 2 colour as code type
Additional panel 3 type	KILPITYYP3	integer	Additional panel 3 type as code type
Additional panel 3 value	KILPIARVO3	integer	Additional panel 3 value
Additional panel 3 info	KILPIINFO3	text, 50	Additional panel 3 info
Additional panel 3 text	KILPL_TXT2	text 50	
Additional panel 3 size	KILPIKOKO3	integer	Additional panel 3 size as code value
Additional panel 3 film	KILPIKALV3	integer	Additional panel 3 film type
Additional panel 3 colour	KILPIVARI3	integer	Additional panel 3 colour as code type
Last modified	MUOKKAUSPV	text, 50	time stamp "12.06.2014 13:29:17"
Municipality code	KUNTAKOODI	integer	code value
Validity direction	LIIKSUUNTA	integer	code value, 3 in the direction of the digitization 4 against the direction of the digitization

Name	Code value	Description
Traffic sign type	A1-A33, B1-B2, C1-C48, D1-D11, E1-E30, H1-H26, F1- F57.2, G1-G42, I5-I11 ja I13-I19	See Traffic Sign Type for exact code values
Traffic sign status	1	In the works
	2	Under construction
	3	Permanently enabled (default)
	4	Temporary used
	5	Temporarily disabled
	6	Permanently disabled
Location specification	1	Right side of lane (default)
	2	Left side of the lane
	3	Above the lane
	4	Central island or traffic divider
	5	Longitudinal to the direction of travel
	6	Outside the road and street network, for example a parking area
Type of damage	1	Rusted
	2	Battered
	3	Painting

	4	Other damage
	null	Not known
Old traffic sign code		See <i>Traffic Sign Type</i> for exact code values
Size	1	Compact traffic sign
	2	Normal-sized traffic sign (default)
	3	Large sign
Lane	11 ja/tai 21 tai 31 12, 13, 14... 22,23, 24...	The lane numbering can be checked in the lane definition of the Finnish transport infrastructure agency
Lane type	1	Main lane
	2	Fast lane
	3	Turn right
	4	Turn left
	5	Extra lane for direct drivers
	6	Access lane (if not part of the ramp)
	7	Separation lane (if not part of the ramp)
	8	Mixing lane
	9	Public transport lane / taxi lane
	10	Heavy traffic lane
	11	Reversible lane
	12	Bicycle lane
	20	Combined bike path and sidewalk
	21	Sidewalk
	22	Cycle path
	23	Pedestrian zone
	24	Bicycle street
Structure	1	Pillar
	2	Wall
	3	Bridge
	4	Portal
	5	Half portal
	6	Boom or other barrier structure
	7	Other
	null	Not known
Condition	1	Very bad
	2	Bad
	3	Satisfying

	4	Good
	5	Very good
	null	Not known
Type of film	1	R1-class film
	2	R2-class film
	3	R3-class film
	null	Not known
Urgency of repair	1	Of great urgency
	2	Urgent
	3	Somewhat urgent
	4	Not urgent
	null	Not known
The substance of the sign	1	Plywood
	2	Aluminum
	3	Other
	null	Not known
The colour of Additional plate	1	Blue
	2	Yellow
	null	Not known
Validity direction	2	In the direction of digitization
	3	Against the direction of digitization

Railway crossing

Point

Description	Field (shape)/ Element (WFS)	Data (shape)	Additional information
ID	ID	text, 20	
Position	shape/point	geometry (pointZ)	ETRS-TM35FIN
Link ID	LINK_ID	text, 20	
Distance from the start of the link	SIJAINTI_M	double	
Name of the railway crossing	NIMI	text, 200	
Type of safety device	TURVA_VAR	Integer	code value

Last edited	MUOKKAUSPV	text, 50	time stamp "12.06.2014 13:29:17"
Municipality code	KUNTAKOODI	integer	

Name	Code value	Description
Type of safety device	1	Railway not in use
	2	No safety device
	3	Only light and/or sound signal
	4	Half barrier and possible light and/or sound signal
	5	Full barrier and possible light and/or sound signal

Speed limit

Line

Description	Field (shape)/ Element (WFS)	Data type (shape)	Additional information
ID	ID	text, 20	
Position	shape/ points	geometry (pol- ylineZ)	ETRS-TM35FIN
Link ID	LINK_ID	text, 20	
Start distance from the start of the link	ALKU_M	double	
End distance from the start of the link	LOPPU_M	double	
Validity direction	VAIK_SUUNT	integer	code value
Value	ARVO	integer	code value, km/h
Last edited	MUOKKAUSPV	text, 50	time stamp "12.06.2014 13:29:17"
Municipality code	KUNTAKOODI	integer	

Name	Code value	Description
Validity direction	1	Both directions
	2	In the direction of digitisation
	3	Against the direction of digitisation
Value	20	20 km/h
	30	30 km/h

	40	40 km/h
	50	50 km/h
	60	60 km/h
	70	70 km/h
	80	80 km/h
	90	90 km/h (Åland)
	100	100 km/h
	120	120 km/h

Maximum total weight

Line

Description	Field (shape)/Element (WFS)	Data type (shape)	Additional information
ID	<i>ID</i>	<i>text, 20</i>	
Position	<i>shape/ points</i>	<i>geometry (pol- ylineZ)</i>	<i>ETRS-TM35FIN</i>
Link ID	<i>LINK_ID</i>	<i>text, 20</i>	
Start distance from the start of the link	<i>ALKU_M</i>	<i>double</i>	
End distance from the start of the link	<i>LOPPU_M</i>	<i>double</i>	
Validity direction	<i>VAIK_SUUNT</i>	<i>integer</i>	<i>code value</i>
Value	<i>ARVO</i>	<i>integer</i>	<i>kilogramme</i>
Last edited	<i>MUOKKAUSPV</i>	<i>text, 50</i>	<i>time stamp "12.06.2014 13:29:17"</i>
Municipality code	<i>KUNTAKOODI</i>	<i>integer</i>	

Maximum total weight allowed for an articulated vehicle

Line

Description	Field (shape)/Element (WFS)	Data type (shape)	Additional information
ID	<i>ID</i>	<i>text, 20</i>	
Position	<i>shape/points</i>	<i>geometry (pol-ylinesZ)</i>	<i>ETRS-TM35FIN</i>
Link ID	<i>LINK_ID</i>	<i>text, 20</i>	
Start distance from the start of the link	<i>ALKU_M</i>	<i>double</i>	
End distance from the start of the link	<i>LOPPU_M</i>	<i>double</i>	
Validity direction	<i>VAIK_SUUNT</i>	<i>integer</i>	<i>code value</i>
Value	<i>ARVO</i>	<i>integer</i>	<i>kilogramme</i>
Last edited	<i>MUOKKAUSPV</i>	<i>text, 50</i>	<i>time stamp "12.06.2014 13:29:17"</i>
Municipality code	<i>KUNTAKOODI</i>	<i>integer</i>	

Maximum weight per axle

Line

Description	Field (shape)/Element (WFS)	Data type (shape)	Additional information
ID	<i>ID</i>	<i>text, 20</i>	
Position	<i>shape/points</i>	<i>geometry (pol-ylinesZ)</i>	<i>ETRS-TM35FIN</i>
Link ID	<i>LINK_ID</i>	<i>text, 20</i>	
Start distance from the start of the link	<i>ALKU_M</i>	<i>double</i>	
End distance from the start of the link	<i>LOPPU_M</i>	<i>double</i>	
Validity direction	<i>VAIK_SUUNT</i>	<i>integer</i>	<i>code value</i>
Value	<i>ARVO</i>	<i>integer</i>	<i>kilogramme</i>
Last edited	<i>MUOKKAUSPV</i>	<i>text, 50</i>	<i>time stamp "12.06.2014 13:29:17"</i>
Municipality code	<i>KUNTAKOODI</i>	<i>integer</i>	

Maximum weight per tandem-axle

Line

Description	Field (shape)/ Element (WFS)	Data type (shape)	Additional information
ID	ID	text, 20	
Position	shape/points	geometry (polylineZ)	ETRS-TM35FIN
Link ID	LINK_ID	text, 20	
Start distance from the start of the link	ALKU_M	double	
End distance from the start of the link	LOPPU_M	double	
Validity direction	VAIK_SUUNT	integer	code value
Value	ARVO	integer	kilogramme
Last edited	MUOKKAUSPV	text, 50	time stamp "12.06.2014 13:29:17"
Municipality code	KUNTAKOODI	integer	

Maximum height

Line

Description	Field (shape)/ Element (WFS)	Data type (shape)	Additional information
ID	ID	text, 20	
Position	shape/points	geometry (polylineZ)	ETRS-TM35FIN
Link ID	LINK_ID	text, 20	
Start distance from the start of the link	ALKU_M	double	
End distance from the start of the link	LOPPU_M	double	
Validity direction	VAIK_SUUNT	integer	code value
Value	ARVO	integer	centimetre
Last edited	MUOKKAUSPV	text, 50	time stamp "12.06.2014 13:29:17"
Municipality code	KUNTAKOODI	integer	

Maximum length allowed for a vehicle or articulated vehicle

Line

Description	Field (shape)/ Element (WFS)	Data type (shape)	Additional information
ID	<i>ID</i>	<i>text, 20</i>	
Position	<i>shape/points</i>	<i>geometry (polylineZ)</i>	<i>ETRS-TM35FIN</i>
Link ID	<i>LINK_ID</i>	<i>text, 20</i>	
Start distance from the start of the link	<i>ALKU_M</i>	<i>double</i>	
End distance from the start of the link	<i>LOPPU_M</i>	<i>double</i>	
Validity direction	<i>VAIK_SUUNT</i>	<i>integer</i>	<i>code value</i>
Value	<i>ARVO</i>	<i>integer</i>	<i>centimetre</i>
Last edited	<i>MUOKKAUSPV</i>	<i>text, 50</i>	<i>time stamp "12.06.2014 13:29:17"</i>
Municipality code	<i>KUNTAKOODI</i>	<i>integer</i>	

Maximum width

Line

Description	Field (shape)/Element (WFS)	Data type (shape)	Additional information
ID	<i>ID</i>	<i>text, 20</i>	
Position	<i>shape/points</i>	<i>geometry (polylineZ)</i>	<i>ETRS-TM35FIN</i>
Link ID	<i>LINK_ID</i>	<i>text, 20</i>	
Start distance from the start of the link	<i>ALKU_M</i>	<i>double</i>	
End distance from the start of the link	<i>LOPPU_M</i>	<i>double</i>	
Validity direction	<i>VAIK_SUUNT</i>	<i>integer</i>	<i>code value</i>
Value	<i>ARVO</i>	<i>integer</i>	<i>centimetre</i>
Last edited	<i>MUOKKAUSPV</i>	<i>text, 50</i>	<i>time stamp "12.06.2014 13:29:17"</i>
Municipality code	<i>KUNTAKOODI</i>	<i>integer</i>	

Lit road

Line

Description	Field (shape)/ Element (WFS)	Data type (shape)	Additional information
ID	<i>ID</i>	<i>text, 20</i>	
Position	<i>shape/ points</i>	<i>geometry (polylineZ)</i>	<i>ETRS-TM35FIN</i>
Link ID	<i>LINK_ID</i>	<i>text, 20</i>	
Start distance from the start of the link	<i>ALKU_M</i>	<i>double</i>	
End distance from the start of the link	<i>LOPPU_M</i>	<i>double</i>	
Last edited	<i>MUOKKAUSPV</i>	<i>text, 50</i>	<i>time stamp "12.6.2014 13:29:17"</i>
Municipality code	<i>KUNTAKOODI</i>	<i>integer</i>	

Paved road

Line

Description	Field (shape)/ Element (WFS)	Data type (shape)	Additional information
ID	<i>ID</i>	<i>text, 20</i>	
Position	<i>shape/points</i>	<i>geometry (polylineZ)</i>	<i>ETRS-TM35FIN</i>
Link ID	<i>LINK_ID</i>	<i>text, 20</i>	
Start distance from the start of the link	<i>ALKU_M</i>	<i>double</i>	
End distance from the start of the link	<i>LOPPU_M</i>	<i>double</i>	
Value	<i>ARVO</i>	<i>integer</i>	
Last edited	<i>MUOKKAUSPV</i>	<i>text, 50</i>	<i>time stamp "12.6.2014 13:29:17"</i>
Municipality code	<i>KUNTAKOODI</i>	<i>integer</i>	

Road affected by thawin

Line

Description	Field (shape)/Element (WFS)	Data type (shape)	Additional information
ID	<i>ID</i>	<i>text, 20</i>	
Position	<i>shape/points</i>	<i>geometry (polylineZ)</i>	<i>ETRS-TM35FIN</i>
Link ID	<i>LINK_ID</i>	<i>text, 20</i>	
Start distance from the start of the link	<i>ALKU_M</i>	<i>double</i>	
End distance from the start of the link	<i>LOPPU_M</i>	<i>double</i>	
Last edited	<i>MUOKKAUSPV</i>	<i>text, 50</i>	<i>time stamp "12.06.2014 13:29:17"</i>
Municipality code	<i>KUNTAKOODI</i>	<i>integer</i>	

Width

Line

Description	Field (shape)/Element (WFS)	Data type (shape)	Additional information
ID	<i>ID</i>	<i>text, 20</i>	
Position	<i>shape/points</i>	<i>geometry (polylineZ)</i>	<i>ETRS-TM35FIN</i>
Link ID	<i>LINK_ID</i>	<i>text, 20</i>	
Start distance from the start of the link	<i>ALKU_M</i>	<i>double</i>	
End distance from the start of the link	<i>LOPPU_M</i>	<i>double</i>	
Road width	<i>ARVO</i>	<i>integer</i>	<i>centimetre</i>
Last edited	<i>MUOKKAUSPV</i>	<i>text, 50</i>	<i>time stamp "12.6.2014 13:29:17"</i>
Municipality code	<i>KUNTAKOODI</i>	<i>integer</i>	

Road work

Line

Selite	Kenttä (shape)/ elementti (WFS)	Tietotyyppi (shape)	Lisätieto
--------	---------------------------------	---------------------	-----------

ID	<i>ID</i>	<i>text, 20</i>	
Position	<i>shape/points</i>	<i>geometry (polylineZ)</i>	<i>ETRS-TM35FIN</i>
Link ID	<i>LINK_ID</i>	<i>text, 20</i>	
Start distance from the start of the link	<i>ALKU_M</i>	<i>double</i>	
End distance from the start of the link	<i>LOPPU_M</i>	<i>double</i>	
Traffic volume	<i>ARVO</i>	<i>integer</i>	<i>vehicle per day</i>
Last edited	<i>MUOKKAUSPV</i>	<i>text, 50</i>	<i>time stamp "12.6.2014 13:29:17"</i>
Municipality code	<i>KUNTAKOODI</i>	<i>integer</i>	
Work ID	<i>TYONUMERO</i>	<i>string</i>	<i>Työn tunnus</i>
Estimated Start Date	<i>KESTOALKU_1</i>	<i>text, 50</i>	<i>Timestamp of estimated start date</i>
Estimated end Date	<i>KESTOLOPP_1</i>	<i>text, 50</i>	<i>Timestamp of estimated ready date</i>

Treatment class

Line

Selite	Kenttä (shape)/ elementti (WFS)	Tietotyyppi (shape)	Lisätieto
ID	<i>ID</i>	<i>text, 20</i>	
Position	<i>shape/points</i>	<i>geometry (polylineZ)</i>	<i>ETRS-TM35FIN</i>
Link ID	<i>LINK_ID</i>	<i>text, 20</i>	
Start distance from the start of the link	<i>ALKU_M</i>	<i>double</i>	
End distance from the start of the link	<i>LOPPU_M</i>	<i>double</i>	
Validity direction	<i>VAIK_SUUNT</i>	<i>integer</i>	<i>code value</i>
Treatment class	<i>ARVO</i>	<i>integer</i>	<i>Treatment class</i>
Last edited	<i>MUOKKAUSPV</i>	<i>text, 50</i>	<i>time stamp "12.6.2014 13:29:17"</i>
Municipality code	<i>KUNTAKOODI</i>	<i>integer</i>	

Parking ban

Line

Selite	Kenttä (shape)/ elementti (WFS)	Tietotyyppi (shape)	Lisätieto
ID	ID	text, 20	
Position	shape/points	geometry (polylineZ)	ETRS-TM35FIN
Link ID	LINK_ID	text, 20	
Start distance from the start of the link	ALKU_M	double	
End distance from the start of the link	LOPPU_M	double	
Validity direction	VAIK_SUUNT	integer	code value
Parking ban	KIELL_TYYP	integer	Type of restriction
Validity period	VOIM_AIKA	text, 50	
Last edited	MUOKKAUSPV	text, 50	time stamp "12.6.2014 13:29:17"
Municipality code	KUNTAKOODI	integer	

Private roads with road associations

Line

Selite	Kenttä (shape)/ elementti (WFS)	Tietotyyppi (shape)	Lisätieto
ID	ID	text, 20	
Position	shape/points	geometry (polylineZ)	ETRS-TM35FIN
Link ID	LINK_ID	text, 20	
Start distance from the start of the link	ALKU_M	double	
End distance from the start of the link	LOPPU_M	double	
Last edited	MUOKKAUSPV	text, 50	time stamp "12.6.2014 13:29:17"
Municipality code	KUNTAKOODI	integer	
Road name finnish	TIENIMI_SU	text, 50	
Road name svedish	TIENIMI_RU	text, 50	

Additional information	LISATIEDOT	text, 200	Additional information whether there are any restrictions on the road
-------------------------------	------------	-----------	---

Traffic volume

Line

Description	Field (shape)/ Element (WFS)	Data type (shape)	Additional information
ID	ID	text, 20	
Position	shape/ points	geometry (pol- ylineZ)	ETRS-TM35FIN
Link ID	LINK_ID	text, 20	
Start distance from the start of the link	ALKU_M	double	
End distance from the start of the link	LOPPU_M	double	
Traffic volume	ARVO	integer	vehicles per day
Last edited	MUOKKAUSPV	text, 50	time stamp "12.6.2014 13:29:17"
Municipality code	KUNTAKOODI	integer	

Vehicle specific restriction

Line

Description	Field (shape)/ Element (WFS)	Data type (shape)	Additional information
ID	ID	text, 20	If one restriction includes several prohibited vehicle types, overlapping objects are included in the shapefile. These objects have the same restriction ID.
Position	shape/ points	geometry (pol- ylineZ)	ETRS-TM35FIN
Link ID	LINK_ID	text, 20	
Start distance from the start of the link	ALKU_M	double	
End distance from the start of the link	LOPPU_M	double	
Validity direction	VAIK_SUUNT	integer	code value
Type of prohibited vehicle	KIELL_AJON	integer	code value

Validity period	VOIM_AIKA	Text, 200	
Exceptions	POIKKEUS	text, 40	comma-separated list of exceptions
Last edited	MUOKKAUSPV	text, 50	time stamp "12.06.2014 13:29:17"
Municipality code	KUNTAKOODI	integer	

Name	Code value	Description
Validity direction	1	Both directions
	2	In the direction of digitisation
	3	Against the direction of digitisation
Vehicle type	2	Motor vehicle
	3	Vehicle
	4	Truck
	5	Bus
	6	Delivery vehicle
	7	Passenger car
	8	Taxi
	9	Motorcycle
	10	Moped
	11	Cycle
	12	Pedestrian
	13	Articulated vehicle
	14	Tractor or farm vehicle
	15	Car with trailer / recreational vehicle
	19	Military vehicle
	21	Driving in service purposes
	22	Driving to a lot
	23	Passage through
	26	Horse riding
	27	Snow mobile
	28	Special transport

Restriction for the transportation of dangerous goods (VAK)

Line

Description	Field (shape) /Element (WFS)	Data type (shape)	Additional information
ID	ID	text, 20	If one restriction includes both A-VAK and B-VAK, overlapping objects are included in the shapefile. These objects have the same restriction ID.
Position	shape/ points	geometry (pol- ylineZ)	ETRS-TM35FIN
Link ID	LINK_ID	text, 20	
Start distance from the start of the link	ALKU_M	double	
End distance from the start of the link	LOPPU_M	double	
Validity direction	VAIK_SUUNT	integer	code value
Type of prohibited vehicle	KIELL_AJON	integer	code value
Validity period	VOIM_AIKA	Text, 200	
Last edited	MUOKKAUSPV	text, 50	time stamp "12.06.2014 13:29:17"
Municipality code	KUNTAKOODI	integer	

Name	Code value	Description
Validity direction	1	Both directions
	2	In the direction of digitisation
	3	Against the direction of digitisation
Vehicle type	24	A-VAK
	25	B-VAK

Number of lanes*

Line

Description	Field (shape)/ Element(WFS)	Data type (shape)	Additional information
ID	ID	text, 20	
Position	shape/ points	geometry (pol- ylineZ)	ETRS-TM35FIN
Link ID	LINK_ID	text, 20	
Start distance from the start of the link	ALKU_M	double	
End distance from the start of the link	LOPPU_M	double	
Validity direction	VAIK_SUUNT	integer	code value
Number of lanes*	ARVO	integer	number of lanes per carriage way
Last edited	MUOKKAUSPV	text, 50	time stamp "12.06.2014 13:29:17"
Municipality code	KUNTAKOODI	integer	

*) The number of lanes is not yet maintained by Digiroad or included in the publication

Public transport lane

Line

Description	Field (shape)/ Element (WFS)	Data type (shape)	Additional information
ID	ID	text, 20	
Position	shape/points	geometry (pol- ylineZ)	ETRS-TM35FIN
Link ID	LINK_ID	text, 20	
Start distance from the start of the link	ALKU_M	double	
End distance from the start of the link	LOPPU_M	double	
Validity direction	VAIK_SUUNT	integer	code value
<i>Validity period*</i>	VOIM_AIKA	text, 200	time domain
Last edited	MUOKKAUSPV	text, 50	time stamp "12.06.2014 13:29:17"
Municipality code	KUNTAKOODI	integer	

*) The feature information in gray is not yet maintained by Digiroad or included in the publication

E-road number

Line

Description	Field (shape)/Element (WFS)	Data type (shape)	Additional information
ID	<i>ID</i>	<i>text, 20</i>	
Position	<i>shape/points</i>	<i>geometry (pol- ylineZ)</i>	<i>ETRS-TM35FIN</i>
Link ID	<i>LINK_ID</i>	<i>text, 20</i>	
Start distance from the start of the link	<i>ALKU_M</i>	<i>double</i>	
End distance from the start of the link	<i>LOPPU_M</i>	<i>double</i>	
E-road number	<i>EURTIENRO</i>	<i>text, 20</i>	<i>comma-separated list of E-road numbers</i>
Last edited	<i>MUOKKAUSPV</i>	<i>text, 50</i>	<i>time stamp "12.06.2014 13:29:17"</i>
Municipality code	<i>KUNTAKOODI</i>	<i>integer</i>	

Exit number

Line

Description	Field (shape)/ Element (WFS)	Data type (shape)	Additional information
ID	<i>ID</i>	<i>text, 20</i>	
Position	<i>shape/points</i>	<i>geometry (pol- ylineZ)</i>	<i>ETRS-TM35FIN</i>
Link ID	<i>LINK_ID</i>	<i>text, 20</i>	
Start distance from the start of the link	<i>ALKU_M</i>	<i>double</i>	
End distance from the start of the link	<i>LOPPU_M</i>	<i>double</i>	
Exit number	<i>LIITT_NRO</i>	<i>text, 20</i>	<i>comma-separated list of exit numbers exit number can also include letters</i>
Last edited	<i>MUOKKAUSPV</i>	<i>text, 50</i>	<i>time stamp "12.06.2014 13:29:17"</i>
Municipality code	<i>KUNTAKOODI</i>	<i>integer</i>	

Winter speed limit

Line

Description	Field (shape)/ Element (WFS)	Data type (shape)	Additional information
ID	<i>ID</i>	<i>text, 20</i>	
Position	<i>shape/points</i>	<i>geometry (pol- ylineZ)</i>	<i>ETRS-TM35FIN</i>
Link ID	<i>LINK_ID</i>	<i>text, 20</i>	
Start distance from the start of the link	<i>ALKU_M</i>	<i>double</i>	
End distance from the start of the link	<i>LOPPU_M</i>	<i>double</i>	
Validity direction	<i>VAIK_SUUNT</i>	<i>integer</i>	<i>code value</i>
Value	<i>ARVO</i>	<i>integer</i>	<i>code value, km/h</i>
Last edited	<i>MUOKKAUSPV</i>	<i>text, 50</i>	<i>time stamp "12.06.2014 13:29:17"</i>
Municipality code	<i>KUNTAKOODI</i>	<i>integer</i>	

Name	Code value	Description
Validity direction	1	<i>Both directions</i>
	2	<i>In the direction of digitisation</i>
	3	<i>Against the direction of digitisation</i>
Value	60	<i>60 km/h</i>
	70	<i>70 km/h</i>
	80	<i>80 km/h</i>
	100	<i>100 km/h</i>

Service Point

Description	Field (shape)/ Element (WFS)	Data type (shape)	Additional information
Service point ID	<i>PALVPISTID</i>	<i>text, 20</i>	<i>If one service point has many services, each of them is presented as an individual data object in service shapefile.</i>
Service ID	<i>PALVELUID</i>	<i>text, 20</i>	
Position	<i>shape/point</i>	<i>geometry (pointZ)</i>	<i>ETRS-TM35FIN</i>
Type of service	<i>TYYPPI</i>	<i>integer</i>	<i>code value</i>
Specifier of the service type	<i>TYYPPI_TAR</i>	<i>integer</i>	<i>code value</i>
Name of service	<i>NIMI</i>	<i>text, 200</i>	

Additional information of the service	LISATIEDOT	text, 200	
Number of parking spaces	PYSPAIKLKM	integer	
Last edited	MUOKKAUSPV	text, 50	time stamp "12.06.2014 13:29:17"
Municipality code	KUNTAKOODI	integer	

Name	Code value	Description
Type of service	4	Customs
	5	Border crossing
	6	Rest area (or lay-by)
	8	Airport
	9	Ferry terminal
	10	Taxi stand
	11	Railway station
	12	Parking lot
	13	Car shipping terminal
	14	Coach and lorry parking (lot?)
	15	Parking house/building
	16	Bus station
	19	Drum tube
Type of rest area	1	Rest area, comprehensive facilities
	2	Rest area, basic facilities
	3	Private service area
	4	No data
Type of railway station	1	Important railway station
	2	Less important railway station
	3	Underground/metro station

5.2 Appendix 2. Public transport stop facility data and other attribute data

Attribute data	Tietotyyppi	Description	Code values
----------------	-------------	-------------	-------------

Digiroad

Timetable	Code value	Paper copy of a timetable in a frame attached to the stop wall or post. Provides information on departure times for the routes serving the stop and, where applicable, stop-specific estimated passing times.	1 No 2 Yes 99 No data
Shelter	Code value	A weather shelter located in the stop area for the use of waiting public transport passengers.	1 No 2 Yes 99 No data
Advertising shelter	Code value	A weather shelter displaying advertising, located in the stop area for the use of waiting public transport passengers. In this case, the advertiser will be responsible for the stop maintenance.	1 No 2 Yes 99 No data
Bench	Code value	A bench located in the stop area for the use of waiting public transport passengers. Usually placed under the stop shelter.	1 No 2 Yes 99 No data
Electronic timetable board	Code value	An electronic timetable board found in the stop area and providing real-time information for the routes serving the stop.	1 No 2 Yes 99 No data
Lighting	Code value	Stop lighting usually refers to the recessed lighting elements in the stop ceiling that provide light inside the shelter.	1 No 2 Yes 99 No data
Accessibility to persons with reduced mobility	Text field	A stop is accessible if it enables independent travelling and waiting by special passenger groups, such as wheelchair users. Stop accessibility is affected by the stop and platform structures, the station and terminal structures and accessibility of the timetable information.	
Possibility to escort by car	Code value	Indicates whether a stop (by a class I road) has a separate passenger drop-off/pick-up area.	1 No 2 Yes 99 No data
Number of park-and-ride places	Character string	Number of park-and-ride parking spaces by a stop.	
Additional information on park-and-ride	Character string	Free text field for additional information on park-and-ride.	
Stop owner	Character string	Stop owner may be other than the data administrator.	
Feedback address	Character string	Address for sending feedback for the stop. For example, an email address.	
Additional information	Text field	Public comments.	

5.3 Appendix 3. Primary data sources by data objects

Primary data source refers to a party that provides or offers data for the Digiroad database. Digiroad also receives feedback maintenance data from other administrators and users. Feedback data is passed on to the primary data source for checking.

Data object	Road owner*	Primary data source
Road link: geometry	State Municipality Private	National Land Survey of Finland National Land Survey of Finland National Land Survey of Finland
Road link: Link ID	State Municipality Private	DR operator DR operator DR operator
Road link: administrative class	State Municipality Private	National Land Survey of Finland / DR operator National Land Survey of Finland / Finnish Transport infrastructure Agency National Land Survey of Finland / Municipality
Road link: functional class	State Municipality Private	Finnish Transport infrastructure Agency/DR operator Municipality Municipality
Road link: direction of traffic flow**	State Municipality Private	National Land Survey of Finland / DR operator Municipality Municipality
Road link: link type	State Municipality Private	Finnish Transport infrastructure Agency/DR operator Municipality Municipality / road association
Road link: bridge, underpass or tunnel	State Municipality Private	National Land Survey of Finland / DR operator Municipality Municipality
Road link: Road name and ad- dress data	State Municipality Private	National Land Survey of Finland National Land Survey of Finland National Land Survey of Finland
Road link: road address data	State Municipality Private	Finnish Transport infrastructure Agency Finnish Transport infrastructure Agency Finnish Transport infrastructure Agency
Road link: restricted manoeuvre	State Municipality Private	Finnish Transport infrastructure Agency Municipality Municipality
Public transport stop***	State Municipality Private	Finnish Transport infrastructure infrastruc- ture Agency Municipality Municipality
Barrier	State Municipality Private	In Digiroad, not maintained for the time being National Land Survey of Finland /Municipality National Land Survey of Finland /Municipality
Traffic light	State Municipality Private	Finnish Transport infrastructure Agency Municipality Municipality
Pedestrian crossing	State Municipality Private	Finnish Transport infrastructure Agency Municipality Municipality
Directional traffic sign	State Municipality Private	Finnish Transport infrastructure Agency - -

Digiroad

Traffic sing	State Municipality Private	Finnish Transport infrastructure Agency Municipality Municipality / road association
Railway crossing****	State Municipality Private	Finnish Transport infrastructure Agency Finnish Transport infrastructure Agency Finnish Transport infrastructure Agency
Speed limit	State Municipality Private	Finnish Transport infrastructure Agency Municipality Municipality/ road association
Maximum allowed x 7	State Municipality Private	Finnish Transport infrastructure Agency Municipality Municipality/ road association
Lit road	State Municipality Private	Finnish Transport infrastructure Agency Municipality Municipality
Paved road	State Municipality Private	National Land Survey of Finland / Finnish Transport infrastructure Agency National Land Survey of Finland National Land Survey of Finland
Road affected by thawing	State Municipality Private	Finnish Transport infrastructure Agency Municipality Municipality / road association
Width	State Municipality Private	Finnish Transport infrastructure Agency Municipality Municipality
Construction zone	State Municipality Private	Finnish Transport infrastructure Agency Municipality -
No parking	State Municipality Private	Finnish Transport infrastructure Agency Municipality -
Treatment class	State Municipality Private	Finnish Transport infrastructure Agency Municipality -
Community private roads	State Municipality Private	- - Road association
Traffic volume	State Municipality Private	Finnish Transport infrastructure Agency Municipality Municipality
Vehicle specific restriction	State Municipality Private	Finnish Transport infrastructure Agency Municipality Municipality / Roas association
Carriage of dangerous goods (VAK)	State Municipality Private	Finnish Transport infrastructure Agency Municipality Municipality
Number of lanes	State Municipality Private	Finnish Transport infrastructure Agency Municipality Municipality
Public transport lane	State Municipality Private	Finnish Transport infrastructure Agency Municipality Municipality
E-road number	State Municipality Private	Finnish Transport infrastructure Agency - -
Exit number	State Municipality Private	Finnish Transport infrastructure Agency - -

Digiroad

Winter speed limit	State Municipality Private	Finnish Transport infrastructure Agency - -
Service point	State Municipality Private	Finnish Transport infrastructure Agency Municipality Municipality

**) Road owner corresponds to the road link attribute 'administrative class'.*

****) Direction of traffic flow is provided by the National Land Survey of Finland, but this data can be edited in the Digiroad database, and the National Land Survey of Finland data will not reverse the data edited in Digiroad.*

*****) Public transport stops are maintained jointly by municipalities and ELY Centres. Some municipalities are also competent transport authorities and responsible for the stop material for several municipalities.*

******) The rail track register only provides data on state-owned railway crossings.*

5.4 Appendix 4. Time domain character string

5.4.1 General

Time Domain is defined in GDF and it is a way to indicate precise and complex validity periods for various features and attributes. Notation consists of starting time of the validity period and duration of the validity in the following way: $[(\text{starting time})\{\text{duration}\}]$.

For example, $[(M5d1)\{d1\}]$ means:

- Starting time: any year in the fifth month on the 1st day at 00:00:00
- Duration: one day (i.e. 24 hours or 1440 minutes)

STARTING TIME				
Notations of Time Domain starting time				
Unit of time	Compared time	Code	Values (n,x)	Comment
year		yynnn	0..9999	
month	of year	Mnn	1..12	
week	of year	wnn	1..53	
day	of month	dnn	1..28/29/30/31	maximum depends on month
day	of week	tn	1..7	from Sunday to Saturday
day of week	week of month	fxn	x: 1..5	week from beginning of month from where validity begins
	day of week		n: 1..7	from Sunday to Saturday
day of week	week of month	lxn	x: 1..5	week from end of month from where validity begins
	day of week		n: 1..7	from Sunday to Saturday
hour	of day	hnn	0..23	
minute	of hour	mnn	0..59	
second	of minute	snn	0..59	

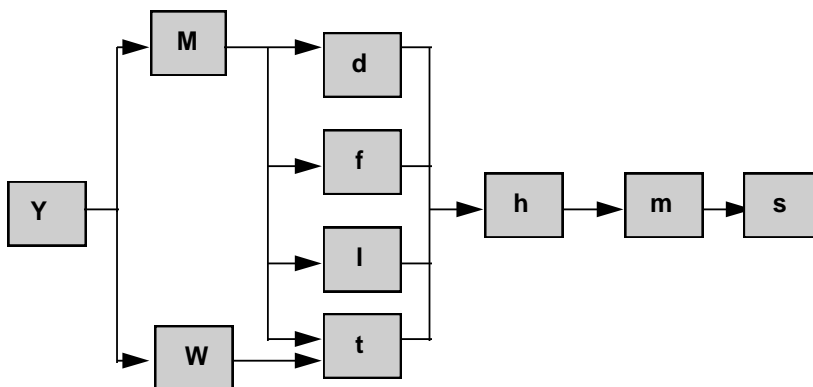

Possible combinations of starting times codes.

Codes are listed from the longest period to the shortest one (y...s). If there is no unit of time marked in the beginning, all values are valid. If there is no unit of time marked in the middle or at the end, the value of the unit is its presumption value, i.e. the smallest possible unit (e.g. M1, w1, d1, h0, m0, s0).

Examples of the notations of starting times:

(y2001)	1.1.2001, 00:00:00
(M5)	every year, 1.5. 00:00:00
(w12)	every year, Sunday on the 12th week, 00:00:00
(d14)	every year, 14th of every month 00:00:00
(t2)	every year, Monday of every week 00:00:00
(f23)	every year, Tuesday of the second week of every month 00:00:00
(l12)	every year, Monday of the last week of every month 00:00:00
(h6)	every year, every day of every month 06:00:00
(m30)	every year, every day of every month, every hour 30:00
(s15)	every year, every day of every month, every hour, every minute :15
(w9h11m30)	every year, every day of the 9th week 11:30:00
(M4m30)	every year, every day of every April, every hour 30:00

Correspondingly:

14th November 2001 (00:00:00)	(y2001M11d14)
every year 2.5. 17:31:00	(M5d2h17m31)
every year, last Sunday of February	(M2l11)

Duration

Duration is the total time of Time Domain notations of time units, e.g. {y2M2w1d2}, which means the validity from starting time onwards, for two years + two months + one week + two days.

A minus sign can be added in front of the duration, e.g. {-d5}, which means the validity on the preceding five days.

Notations of Time Domain duration				
Unit of time	Code	Values (n)	Correspondence	Comments
year	ynn	0..99		Duration ends on the last day of the month if there is no such day in the year when duration ends, e.g. [(y2000M2d29){y2}].
month	Mnn	1..99	{M12}={y1}	Duration ends on the last day of the month if there is no such day in the month when duration ends, e.g. [(y2001M1d31){M1}].
week	wnn	1..99		
day	dnn	1..99	{d7}={w1}	
hour	hnn	0..99	{h24}={d1}	

minute	mnn	0..99	{m60}={h1}	
second	snn	0..99	{s60}={m1}	



Possible combinations of duration.

5.4.2 Time Domain combinations

There are combination options defined in the Time Domain notations that make it possible to indicate more complex durations. The following options are in use:

- $A+B$: property is valid in both cases (OR)
- $A*B$: property is valid when both are valid (AND)
- $A-B$: property is valid when only A is valid (A AND NOT B)

With combinations the same result can be achieved in several different ways, because e.g. $A*(B+C) = (A*B)+(A*C)$.

5.4.3 Examples

- Every day from 9 a.m. to 1 p.m.

$[(h9)\{h4\}]$

- Every Friday in March from 7.30 p.m. to 10 p.m.

$[(M3t6h19m30)\{h2m30\}]$

- The last 15 minutes of the year 2001 (15 minutes before the year 2002)

$[(y2002)\{-m15\}]$

- Every day from Monday to Saturday between 9 a.m. and 12 noon and between 1.30 and 7 p.m., except on the last Tuesday in January, 1st of May and in August

$[[[[(h9)\{h3\}]+[(h13m30)\{h5m30\}]]*[(t2)\{d6\}]]-[(M1t13)\{d1\}]-[(M5)\{d1\}]-[(M8)\{M1\}]]$