

Network Working Group
Request for Comments: 4066
Category: Experimental

M. Liebsch, Ed.
A. Singh, Ed.
H. Chaskar
D. Funato
E. Shim
July 2005

Candidate Access Router Discovery (CARD)

Status of This Memo

This memo defines an Experimental Protocol for the Internet community. It does not specify an Internet standard of any kind. Discussion and suggestions for improvement are requested. Distribution of this memo is unlimited.

Copyright Notice

Copyright (C) The Internet Society (2005).

Abstract

To enable seamless IP-layer handover of a mobile node (MN) from one access router (AR) to another, the MN is required to discover the identities and capabilities of candidate ARs (CARs) for handover prior to the initiation of the handover. The act of discovery of CARs has two aspects: identifying the IP addresses of the CARs and finding their capabilities. This process is called "candidate access router discovery" (CARD). At the time of IP-layer handover, the CAR, whose capabilities are a good match to the preferences of the MN, is chosen as the target AR for handover. The protocol described in this document allows a mobile node to perform CARD.

Table of Contents

1. Introduction.....	2
2. Terminology.....	3
3. CARD Protocol Functions.....	4
3.1. Reverse Address Translation.....	4
3.2. Discovery of CAR Capabilities.....	4
4. CARD Protocol Operation.....	4
4.1. Conceptual Data Structures.....	7
4.2. Mobile Node - Access Router Operation.....	8
4.3. Current Access Router - Candidate Access Router Operation.....	11
4.4. CARD Protocol Message Piggybacking on the MN-AR Interface.....	13

5.	Protocol Messages.....	14
5.1.	CARD Messages for the Mobile Node-Access Router Interface.....	14
5.2.	CARD Inter-Access Router Messages.....	28
6.	Security Considerations.....	31
6.1.	Veracity of CARD Information.....	31
6.2.	Security Association between AR and AR.....	31
6.3.	Security Association between AR and MN.....	32
6.4.	Router Certificate Exchange.....	32
6.5.	DoS Attack.....	34
6.6.	Replay Attacks.....	34
7.	Protocol Constants.....	34
8.	IANA Considerations.....	35
9.	Normative References.....	35
10.	Informative References.....	35
11.	Contributors.....	36
12.	Acknowledgements.....	36
	Appendix A. Maintenance of Address Mapping Tables in Access Routers.....	37
	Appendix A.1. Centralized Approach Using a Server Functional Entity.....	37
	Appendix A.2. Decentralized Approach Using Mobile Terminals' Handover.....	38
	Appendix B. Application Scenarios.....	40
	Appendix B.1. CARD Operation in a Mobile IPv6-Enabled Wireless LAN Network.....	40
	Appendix B.2. CARD Operation in a Fast Mobile IPv6-Enabled Network.....	43

1. Introduction

IP mobility protocols, such as Mobile IP, enable mobile nodes to execute IP-level handover among access routers. Work is underway [Kood03][Malk03] to extend the mobility protocols to allow seamless IP handover. Seamless IP mobility protocols will require knowledge of candidate access routers (CARs) to which a mobile node can be transferred. The CAR discovery protocol enables the acquisition of information about the access routers that are candidates for the mobile node's next handover.

CAR discovery involves identifying a CAR's IP address and the capabilities that the mobile node might use for a handover decision. There are cases in which a mobile node has a choice of CARs. The mobile node chooses one according to a match between the mobile node's requirements for a handover candidate and the CAR's capabilities. However, the decision algorithm itself is out of the scope of this document.

The problem statement for CAR discovery is documented in [TKCK02]. In this document, a protocol is described to perform CAR discovery. Section 3 describes two main functions of the CAR discovery protocol. Section 4 describes the core part of the CARD protocol operation. The protocol message format is described in Section 5. Section 6 discusses security considerations, and Section 7 contains a table of protocol parameters. Appendix A contains two alternative techniques for dynamically constructing the CAR table mapping between the access point L2 ID and Access Router IP address, which is necessary for reverse address translation. The default method is static configuration. Appendix B contains two sample scenarios for using CARD.

2. Terminology

The key words "MUST", "MUST NOT", "REQUIRED", "SHALL", "SHALL NOT", "SHOULD", "SHOULD NOT", "RECOMMENDED", "MAY", and "OPTIONAL" in this document are to be interpreted as described in RFC 2119 [Brad97].

This document uses terminology defined in [MaKo03].

In addition, the following terms are used:

Access Router (AR)

An IP router residing in an access network and connected to one or more APs. An AR offers IP connectivity to MNs.

Candidate AR (CAR)

An AR to which an MN has a choice when performing IP-level handover.

Capability of an AR

A characteristic of the service offered by an AR that may be of interest to an MN when the AR is being considered as a handover candidate.

L2 ID

An identifier of an AP that uniquely identifies that AP. For example, in 802.11, this could be a MAC address of an AP.

CARD Initiating Trigger

An L2 trigger used to initiate the CARD process. For example, a MN can initiate CARD as soon as it detects the L2 ID of a new AP during link layer scan.

Access Point (AP)

A wireless access point, identified by a MAC address, providing service to the wired network for wireless nodes.

3. CARD Protocol Functions

The CARD protocol accomplishes the following functions.

3.1. Reverse Address Translation

If an MN can listen to the L2 IDs of new APs prior to making a decision about IP-level handover to CARs, a mechanism is needed for reverse address translation. This function of the CARD protocol enables the MN to map the received L2 ID of an AP to the IP address of the associated CAR that connects to the AP. To get the CAR's IP address, the MN sends the L2 ID of the AP to the current AR, and the current AR provides the associated CAR's IP address to the MN.

3.2. Discovery of CAR Capabilities

Information about the capabilities of CARs can assist the MN in making optimal handover decisions. This capability information serves as input to the target AR selection algorithm. Some of the capability parameters of CARs can be static, whereas others can change with time.

A definition of capabilities is out of the scope of this document. Encoding rules for capabilities and the format of a capability container for capability transport are specified in Section 5.

4. CARD Protocol Operation

The CARD protocol allows MNs to resolve the L2 ID of one or more APs to the IP addresses of the associated CARs. The L2 IDs are typically discovered during an operation by the MN and are potential handover candidates. Additionally, CARD allows MNs to discover particular capabilities associated with the CARs, such as available bandwidth, that might influence the handover decision of the MN. Furthermore, the protocol allows ARs to populate and maintain their local CAR table (Section 4.1) with the capabilities of CARs. For this, the CARD protocol makes use of CARD Request and CARD Reply messages

between an MN and its current AR (Section 5.1.2), and between an MN's current AR and individual CARs, respectively (Section 5.2.2).

To allow an MN to retrieve a CAR's address and capability information, the CARD Request and CARD Reply messages used between an MN and its current AR may contain one or more access points' L2 IDs and the IP addresses of associated CARs, respectively. Optionally, the CARD Reply messages can also contain a CAR's capability information. A CAR's capabilities are specified as a list of attribute-value pairs, which are conveyed in a Capability Container message parameter.

Information about CARs and associated capabilities MAY be used by the MN to perform target access router selection during its IP handover. The current AR returns replies according to its CAR table (see Section 4.1) and returns a RESOLVER ERROR (see Section 5.1.3.1) if the request cannot be resolved.

The CARD protocol also enables an MN to optionally indicate its preferences on capabilities of interest to its current AR by including the Preferences message parameter in the CARD Request message. The MN's current AR MAY use this information to perform optional capability pre-filtering for optimization purposes, and it returns only these capabilities of interest to the requesting MN. The format of this optional Preferences message parameter is described in Section 5.1.3.2.

Optionally, the MN can provide its current AR with a list of capability attribute-value pairs, indicating not only the capability parameters (attributes) required for capability pre-filtering, but also a specific value for a particular capability. This allows the MN's current AR to perform CAR pre-filtering and to send only address and capability information of CARs whose capability values meet the requirements of the MN back to the requesting MN. The format of this optional Requirements message parameter is described in Section 5.1.3.3.

For example, using the optional Preferences message parameter, an MN may indicate to its current AR that it is interested only in IEEE802.11a interface-specific capability parameters, as this is the only interface the MN has implemented. The MN's current AR sends back only CARs with IEEE802.11a-specific capabilities. Similarly, using the optional Requirements message parameter, an MN may indicate to its current AR that it is only interested in CARs that can satisfy a given QoS constraint. Here, an MN sends the respective QoS attribute with the QoS constraint value to its current AR using the optional Requirements message parameter. The QoS constraint is denoted as an attribute-value pair and encapsulated with the

Requirements message parameter, which is appended to the MN-originated CARD Request message. The Requirements message parameter may be used to indicate the cutoff values of the capabilities for any desired CARs. According to the received optional list of attributes in the Preferences parameter or a list of attribute-value pairs in the Requirements message parameter, the MN's current AR MAY use these parameters for deciding the content of the solicited CARD Reply message, which is to be sent back to the MN. Alternatively, if the MN's current AR does not perform optimization with regard to capability or CAR pre-filtering, the current AR MAY choose to silently ignore the optional Requirements and Preferences message parameter as received in the CARD Request message.

The MN can additionally request from the AR a certification path that is anchored at a certificate from a shared, trusted anchor. The MN includes in the CARD Request message a list of trusted anchors for which the MN has a certificate, and the AR replies with the certification path. If no match is found, the AR returns the trusted anchor names from the CARD Request. The MN can ask for a chain for either the current AR or a CAR. If the trusted anchor list is accompanied by an AP L2 ID for the MN's current AP, the returned chain is for the current AR. If the L2 ID is for an AP that the MN has heard during scanning and is not connected to the current AR, the returned chain is for a CAR. The chain is returned as a sequence of CARD Reply messages, each message containing a single certificate, the L2 identifier for the AP sent in the CARD Request, and a router address for the CAR (or for the AR itself if a request was made for the AR). When the chain is complete, the MN can use it to obtain the AR's certified key and thereby validate signatures on CARD messages and other messages between the MN and the current AR. The MN only has to send the trusted anchor option if it does not have the certification path for the AR already cached. If the MN has the certification path cached, through preconfiguration, through previous receipt of the chain from this router, or by having received the chain through a previous router, then the trusted anchor does not have to be sent. More information about certificate exchange and its use in CARD security can be found in Section 6.

The CARD protocol operation, as described in this section, distinguishes signaling messages exchanged between an MN and its current AR from those exchanged between ARs. Hence, descriptions of signaling messages in the following sections have preceding identifiers referring to the associated interface. Messages that are exchanged between an MN and AR are designated as "MN-AR", and messages between ARs are designated as "AR-AR".

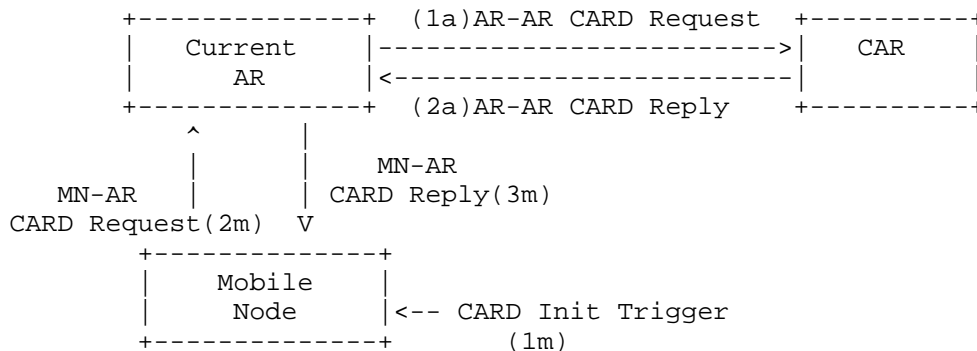

Figure 1: MN-initiated CARD Protocol Overview

Figure 1 describes the operation of the MN-AR CARD Request/Reply protocol and AR-AR CARD Request/Reply protocol. On receipt of the access points' L2 IDs or the appearance of a CARD initiation trigger (1m), the MN may pass on one or more AP L2 IDs to its current AR using the MN-AR CARD Request message (2m). If the MN wants its AR to perform capability discovery in addition to reverse address translation, this must be indicated in the MN-AR CARD Request message by setting the C-flag. If the C-flag is not set, the AR receiving the CARD Request message will perform only reverse address translation. The MN's current AR resolves the L2 ID to the IP address of the associated CAR or, if the MN has not attached any L2 ID message parameters, just reads out all CARs' IP address information using the reverse address translation information (L2 ID to IP address mapping) from its local CAR table. The current AR then returns to the MN using the MN-AR CARD Reply message (3m), the IP addresses of any CARs, each CAR's set of L2 IDs with CANDIDATE indicated in the L2 ID sub-option status field, and, if capability information has been requested, associated capabilities.

For the AR-AR CARD Request/Reply protocol, the requesting AR sends a CARD Request message to its peer when the CAR table entries time out (1a). The peer returns a CARD Reply message with the requested information (2a).

4.1. Conceptual Data Structures

ARs SHALL maintain an L2-L3 address mapping table (CAR table) that is used to resolve L2 IDs of candidate APs to the IP address of the associated CAR. By default, this address-mapping table is configured statically for the CARD protocol operation. Optionally, the CAR table MAY be populated dynamically. Two possible approaches are described in Appendices A.1 and A.2.

ARs SHOULD also keep and maintain individual CARs' capabilities in the local CAR table, with the associated capability lifetime taken into account. If the lifetime of an individual capability entry has expired, the respective capability information is updated. An AR may also initiate capability exchange prior to expiration of the capabilities associated with a CAR in the CAR table, thereby populating its CAR table. The AR's CAR table may be implemented differently; therefore additional details are not provided here. ARs MUST maintain their own AP-to-AR mappings and capability information in their CAR tables, in order to provide newly booted MNs with this information so that an MN can obtain the AR's certification path.

MNs SHOULD maintain discovered address and capability information of CARs in a local cache to avoid requesting the same information repeatedly and to select an appropriate target AR from the list of CARs as quickly as possible when a handover is imminent.

4.2. Mobile Node - Access Router Operation

4.2.1. Mobile Node Operation

To initiate CARD, an MN sends a CARD Request to its current AR, requesting it to resolve the L2 ID of nearby access points to the IP address of associated CARs and also obtain capability parameters associated with these CARs. If the requesting MN wants its current AR to resolve specific L2 IDs, the MN-AR CARD Request MUST contain the CARD protocol-specific L2 ID message parameters. If the MN wants its AR to perform only reverse address translation without appending the CARs' capabilities, the MN refrains from setting the C-flag in the CARD Request message. If the MN wants to perform capability discovery, the MN MUST set the C-flag in the CARD Request message. The CARD Request MAY also contain the Preferences or Requirements message parameter, indicating the MN's preferences on capability attributes of interest or its requirements on CARs' capability attribute-value pairs.

If the MN appends multiple L2 ID sub-options to a CARD Request, the AR MUST assume that each L2 ID is associated with an AP that connects to a different CAR. Since L2 IDs, address information, and capability information are transmitted with separate sub-options, each sub-option carries a Context-ID, to allow parameters that belong together to be matched. Therefore, the MN MUST assign different Context-ID values to the L2 ID sub-options it appends to the CARD Request message. The Status-Code field of the L2 ID sub-option MUST always be set to NONE (0x00) by the MN. The MN MUST set the sequence number to a randomly generated value, and the AR MUST include the sequence number in all messages of the reply. If the reply spans multiple messages, each message contains the same sequence number.

Upon receipt of the corresponding MN-AR CARD Reply message, the MN correlates the CARD Reply with the appropriate CARD Request message and then processes all MN-AR CARD Reply message parameters to retrieve its CAR's address and capability information. If the MN is unable to correlate the CARD Reply with any previously sent CARD Request messages, the MN SHOULD silently discard the reply. This may happen when the MN reboots after sending a CARD Request message to the connected AR.

An MN uses exponential backoff to retransmit the CARD Request in the event that a CARD Reply is not received within `CARD_REQUEST_RETRY` seconds. The retransmitted CARD Request MUST have the same sequence number as the original. With the exception of certification paths, which are large by nature, an AR SHOULD attempt to limit the information in a CARD Reply to a single message. Should that be impossible, the AR MAY send the reply in multiple messages. The last message of a reply MUST always have the L-flag set in the CARD Reply option to indicate that the message is the last for the associated sequence number. An AR retransmitting replies to a CARD Request MUST always send the full CARD Reply sequence. The Trusted Anchor sub-option and the Router Certificate sub-option provide a means whereby the MN can request specific certificates in a certification path, in the event that the CARD Reply carrying a certification path spans multiple messages and one of them is lost. However, a request for specific certificates that were not received in the initial CARD Reply MUST be treated as a new request by the MN and MUST use a different sequence number.

Processing the Context-ID of Address sub-options allows the MN to assign the resolved IP address of a specific CAR to an L2 ID.

In some cases, an L2 ID parameter is present in a CARD Reply message. The Status-Code field in the L2 ID parameter indicates one of the following reasons for its being sent toward the MN.

RESOLVER ERROR Status-Code indication:

If the MN's current AR could not resolve a particular L2 ID, this status code is returned to the MN.

MATCH Status-Code indication:

If an L2 ID is encountered that shares a CAR with a previously resolved L2 ID, the AR returns MATCH to the MN. This status code indicates that the Context-ID of this particular L2 ID sub-option has been set to the Context-ID of the associated CAR's Address and Capability Container sub-option, which is sent with this CARD Reply message. This approach avoids sending the same CAR's address and capability information multiple times with the same CARD Reply message in case two or more L2 IDs resolve to the same

CAR. An MN uses the Context-ID received in the L2 ID sub-option as the key to find the serving CAR of the given AP from the content of the received CARD Reply message.

CANDIDATE Status-Code indication:

If the MN does not append any L2 ID to the CARD Request, the AR sends back the L2 ID and address information of all CARs. Because the received parameters' Context-IDs cannot be correlated with an L2 ID's Context-ID of a previously sent request, the AR chooses values for the Context-ID and marks these candidate L2 IDs with CANDIDATE in the status code of the distributed L2 IDs. However, individual values of L2 IDs' Context-ID allow the MN to assign a particular L2 ID to the associated Address and the possibly received Capability Container sub-option.

As described in Section 4.5, an MN can use CARD when it initially boots up to determine whether piggyback operation is possible. An MN can also use CARD initially to determine the capabilities and certificates for an AR on which it boots up or if it cannot obtain the certificates beforehand. To do this, the MN includes an L2 Identifier option with its current AP L2 ID and the requested information. The AR replies with its own information.

4.2.2. Current Access Router Operation

Upon receipt of an MN's MN-AR CARD Request, the connected AR SHALL resolve the requested APs' L2 ID to the IP address of any associated CARs. If no L2 ID parameter has been sent with the MN-AR CARD Request message, the receiving AR retrieves all CARs' IP addresses and, if the C-flag was set in the request, the capability information.

In the first case, where the AR resolves only requested L2 IDs, the AR does not send back the L2 ID to the requesting MN. If, however, two or more L2 IDs match the same CAR information, the L2 ID sub-option is sent back to the MN, indicating a MATCH in the Status-Code field of the L2 ID. Furthermore, the AR sets the Context-ID of the returned L2 ID to the value of the resolved CAR's L2 ID, Address, and Capability Container sub-option. If an AR cannot resolve a particular L2 ID, an L2 ID sub-option is sent back to the MN, indicating a RESOLVER ERROR in the L2 ID sub-option's Status-Code field.

In the second case, where the AR did not receive any L2 ID with a CARD Request, all candidate APs' L2 IDs are sent to a requesting MN with the CARD Reply message. The AR marks the Status-Code of individual L2 IDs as CANDIDATE, indicating to the MN that the

associated Context-ID cannot be matched with the ID of a previously sent request.

In any case, the AR MUST set the Context-ID of the Address and the Capability Container sub-option to the same value as that of the associated L2 ID sub-option.

Optionally, when allowed by local policies and supported by respective ARs for capability discovery, the AR MAY retrieve a subset of capabilities or CARs, satisfying the optionally appended Preferences and Requirement message parameter, from its local CAR table. CARs' address information and associated capabilities are then delivered to the MN using the MN-AR CARD Reply message. The CARs' IP address and the capabilities SHALL be encoded according to the format for CARD protocol message parameters as defined in Section 5.1.3 of this document. The capabilities are encoded as attribute-value pairs, which are encapsulated in a Capability Container message parameter according to the format defined in Section 5.1.3.4. The responding current AR SHALL copy the sequence number received in the MN-AR CARD Request to the MN-AR CARD Reply.

4.3. Current Access Router - Candidate Access Router Operation

4.3.1. Current Access Router Operation

The MN's current AR MAY initiate capability exchange with CARs either when it receives an MN-AR CARD Request or when it detects that one or more of its local CAR table's capability entries' lifetimes are about to expire. An AR SHOULD preferentially utilize its CAR table to fulfill requests rather than signal the CAR directly, and it SHOULD keep the CAR table up to date for this purpose, in order to avoid injecting unnecessary delays into the MN response.

The AR SHOULD issue an AR-AR CARD Request to the respective CARs if complete capability information of a CAR is not available in the current AR's CAR table, or if such information is expired or about to expire. The AR-AR CARD Request message format is defined in Section 5.2.2. The sequence number on the AR-AR interface starts with zero when the AR reboots. The sending AR MUST increment the sequence number in the CARD Request by one each time it sends a CARD Request message.

The AR MAY append its own capabilities, which are encoded as attribute-value pairs and encapsulated with the Capability Container message parameter, to the released AR-AR CARD Request. If the AR-AR CARD Request conveys the current AR's capabilities to the CAR, the associated Capability Container can have any value set for the Context-ID, as there is no need for the receiving CAR to process this

field due to the absence of an L2 ID and an Address sub-option. Furthermore, the current AR MAY set the P-flag in the Capability Container sub-option to inform the CAR about its own capability to perform CARD protocol message piggybacking.

Optionally, a current AR MAY append the Preferences sub-option to the AR-AR CARD Request to obtain only capability parameters of interest from a CAR.

Upon receipt of the AR-AR CARD Reply, sent by the CAR in response to the previously sent request, the MN's current AR SHALL extract the capability information from the payload of the received message and store the received capabilities in its local CAR table. The lifetime of individual capabilities is to be set according to the lifetime indicated for each capability received. The values of the table entries' timeouts shall depend upon the nature of individual capabilities.

Optionally, CARs can send unsolicited CARD Reply messages to globally adjacent ARs if the configuration of their APs or capabilities changes dynamically. If the current AR receives an unsolicited CARD Reply message from a CAR for which there is an entry in its local CAR table, the current AR checks that the sequence number of the received CARD Reply has increased compared to that of the previously received unsolicited CARD Reply message, which has been sent from the same CAR. Then, the current AR can update its local CAR table according to the received capabilities. If a new CAR is added, an AR may receive a CARD Reply from a CAR that is not in its CAR table, or from a CAR that has rebooted. In this case, the sequence number is 0. The requirement that ARs share an IPsec security association, detailed in Section 6, ensures that an AR never accepts CARD information from an unauthenticated source.

4.3.2. Candidate Access Router Operation

Upon receipt of an AR-AR CARD Request, a CAR shall extract the sending AR's capabilities, if the sending AR has included its capabilities. The CAR SHALL store the received capabilities in its CAR table and set the timer for individual capabilities appropriately. The values of the table entries' timeouts depend on the nature of capabilities in the AR-AR CARD Reply message. The CAR must include the same sequence number in the AR-AR CARD Reply Message as that received in the AR-AR CARD Request Message. The AR-AR CARD Reply shall include the CAR's capabilities as list of attribute-value pairs in the Capability Container message parameter. If the sending AR has appended an optional Preferences sub-option, the CAR MAY perform capability filtering and send back only those capabilities of interest to the requesting AR, identified according to the

Preferences sub-option. Because the AR-AR CARD Reply is based on a previously received AR-AR CARD Request, the CAR MUST set the U-flag of the AR-AR CARD Reply to 0.

Optionally, the CAR MAY send an unsolicited CARD Reply message to globally adjacent ARs if one or more of its capability parameters change. Each unsolicited CARD Reply message should have as destination address the adjacent AR's unicast address and must have the U-flag set. Consecutive unsolicited CARD Reply messages MUST have the sequence number incremented accordingly, starting with 0 when the AR boots.

4.4. CARD Protocol Message Piggybacking on the MN-AR Interface

CARD supports another mode of CAR information distribution, in which the capabilities are piggybacked on fast handover protocol messages. To allow MNs and ARs appending the ICMP-option type CARD Request and CARD Reply (Section 5.1.2) to the ICMP-type Fast Mobile IPv6 [Kood03] signaling messages, the MN and AR should know about the signaling peer's capability for CARD protocol message piggybacking. This requires dynamic discovery of piggybacking capability using the P-flag in the MN-AR CARD Request and the MN-AR CARD Reply message, as well as in the Capability Container message parameter. The format of these messages and parameters is described in Section 5.1.

The MN sends the very first CARD Request to its current AR using the ICMP-type CARD main header for transport, as described in Section 4.2.1. If the MN supports CARD-protocol message piggybacking, the P-flag in this very first CARD Request message is set. On receipt of the CARD Request message, the current AR learns about the MN's piggybacking capability. To indicate its piggybacking capability, the AR sets the P-flag in the CARD Reply message. If the AR does not support piggybacking, all subsequent CARD-protocol messages between the MN and the AR are sent stand-alone, using the CARD main header. If both nodes (the MN and its current AR) support CARD-protocol message piggybacking, subsequent CARD protocol messages can be conveyed as an option via the Fast Mobile IPv6 Router Solicitation for Proxy (RtSolPr) and Proxy Router Advertisement (PrRtAdv) messages. During the CARD process, an MN learns about CARs' piggybacking capability at the discovery phase, as the Capability Container (described in Section 5.1.3.4) also carries a P-flag. This allows the MN to perform CARD protocol message piggybacking immediately after a handover to a selected CAR, assuming that this CAR supports CARD protocol piggybacking.

If a MN prefers the reverse address translation function of the Fast Mobile IPv6 protocol, it can use CARD protocol message piggybacking to retrieve only the CARs' capability information. To indicate that

reverse address translation is not required, the piggybacked CARD Request message MUST have the A-flag set. This causes the current AR to append only Capability Container sub-options. To associate a Capability Container sent as a parameter of the CARD Reply message to the IP address for the appropriate CAR, the Context-ID of an individual Capability Container MUST be used as an index, pointing to the associated IP address in the PrRtAdv message options. The Context-ID of individual Capability Containers is set appropriately by the MN's current AR. Details about how individual Context-ID values can be associated with a particular IP address option of the PrRtAdv message is out of the scope of this document.

5. Protocol Messages

5.1. CARD Messages for the Mobile Node-Access Router Interface

5.1.1. MN-AR Transport

The MN-AR interface uses ICMP for transport. Because ICMP messages are limited to a single packet, and because ICMP contains no provisions for retransmitting packets if signaling is lost, the CARD protocol incorporates provisions for improving transport performance on the MN-AR interface. MNs SHOULD limit the amount of information requested in a single ICMP packet, as ICMP has no provision for fragmentation above the IP level.

MNs and ARs use the Experimental ICMP-type main header [Ke04] when CARD protocol messages cannot be conveyed via ICMP-type Fast Mobile IPv6 [Kood03]. The MN-AR interface MUST implement and SHOULD use the CARD ICMP-type header for transport. If available, the MN-AR interface MAY use the ICMP-type Fast Mobile IPv6 [Kood03] for transport (Section 4.4).

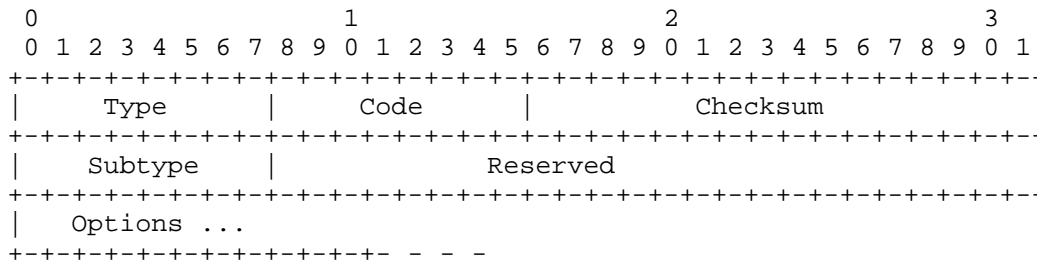

IP Fields:

Source Address:

An IP address assigned to the sending interface.

Destination Address:

An IP address assigned to the receiving interface.

Hop Limit: 255

ICMP Fields:

Type: Experimental Mobility type (assigned by IANA for IPv4 and IPv6, see [Ke04]).

Code: 0

Checksum: The ICMP checksum.

Subtype: Experimental Mobility subtype for CARD; see [Ke04].

Reserved: This field is currently unused. It MUST be initialized to zero by the sender and MUST be ignored by the receiver.

Valid Options:

CARD Request: The CARD Request allows entities to request CARD-specific information from ARs. To support processing of the CARD Request message on the receiver side, further sub-options may be carried, serving as input to the reverse address translation function and/or capability discovery function.

CARD Reply: The CARD Reply carries parameters, previously requested with a CARD Request, back to the sender of the CARD Request.

Valid Sub-Options:

Support level is indicated in parentheses.

Layer-2 ID (mandatory):

The Layer-2 ID sub-option [5.1.3.1] carries information about the type of an access point as well as the Layer-2 address of the access point associated with the CAR whose IP address and capability information is to be resolved.

Capability Container (mandatory):

The Capability Container sub-option carries information about a single CAR's capabilities. The format of this sub-option is described in Section 5.1.3.4.

Address (mandatory):

The Address sub-option carries information on an individual CAR's resolved IP address. The format of the Address sub-option is described in Section 5.1.3.5.

Trusted Anchor (mandatory):

The Trusted Anchor sub-option carries the name of a trusted anchor for which the MN has a certificate. The format of the Trusted Anchor sub-option is described in Section 5.1.3.6.

Router Certificate (mandatory):

The Router Certificate sub-option carries one certificate in the path for the current AR or for a CAR. The chain includes certificates starting at a trusted anchor, which the AR shares in common with the MN, to the router itself. The format of the Router Certificate sub-option is described in Section 5.1.3.7.

Preferences (optional):

The Preferences sub-option carries information about attributes of interest to the requesting entity. Attributes are encoded according to the AVP encoding rule, which is described in Section 5.1.4. For proper settings of AVP Code and Data field, see Section 5.1.3.2. This sub-option is used only if optional capability pre-filtering is performed on ARs, and it provides only capabilities of interest to a requesting MN.

Requirements (optional):

The Requirements sub-option carries information about attribute-value pairs required for pre-filtering of CARs on the MN's current AR. This parameter conveys MN specific attribute-value pairs to allow the MN's current AR to send only information about CARs of interest back to the requesting MN. CARs are filtered on ARs according to the CARs' capability parameters and given policy or threshold, as encoded in the Requirements sub-

option. Attribute-value pairs are encoded according to the AVP encoding rule, which is described in Section 5.1.4. Rules for proper setting of the AVP Code and Data field for the Requirements sub-option are described in Section 5.1.3.3.

CARD Requests that fail to elicit a response are retransmitted. The initial retransmission occurs after a CARD_REQUEST_RETRY wait period. Retransmissions MUST be made with exponentially increasing wait intervals (doubling the wait each time). CARD Requests should be retransmitted until either a response (which might be an error) has been obtained or CARD_RETRY_MAX seconds have occurred. ARs MUST discard any CARD Requests having the same sequence number after CARD_RETRY_MAX seconds. If a CARD Reply spans multiple ICMP messages, the same sequence number MUST be used in each message.

MNs that retransmit a CARD Request use the same CARD sequence number. This allows the AR to cache its reply to the original request and then to send it again, should a duplicate request arrive. This cached information should only be held for a maximum of CARD_RETRY_MAX seconds after receipt of the request. Sequence numbers SHOULD be chosen randomly. Random sequence numbers avoid duplicates if MNs restart frequently and simplify sequence-number maintenance on both the MN and AR when MNs frequently appear and disappear due to movement between CARs.

5.1.2. CARD Options Format

All options are of the following form:

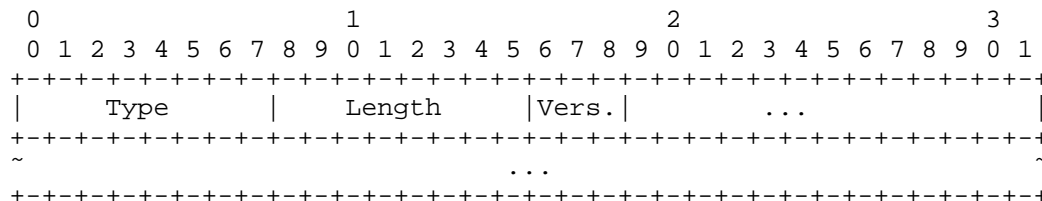

Fields:

- Type: 8-bit identifier of the type of option, assigned by IANA. See [Ke04] for CARD Request and CARD Reply values.
- Length: 8-bit unsigned integer. The length of the option, including the type and length fields in units of 8 octets. The value 0 is invalid.

Vers.: 3-bit version code. For this specification, Vers.=1.

5.1.2.1. CARD Request Option

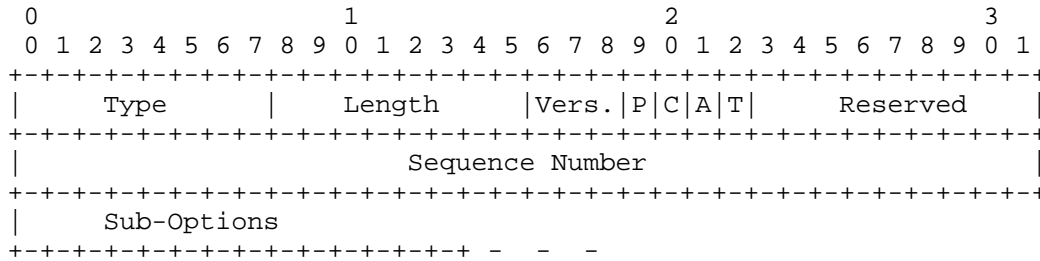

Fields:

Type: Assigned by IANA for IPv4 and IPv6; see [Ke04].

Length: The length of the option in units of 8 octets, including the type and length fields as well as sub-options.

Vers.: 3-bit version code. For this specification, Vers.=1.

Flags: P-flag: Indicates the CARD-protocol message piggybacking capability of the CARD Request message sender. A description for proper use of this flag can be found in Section 4.4 of this document.

C-flag: Indicates that the requesting entity is also interested in associated CARs' capabilities. If the MN wants the AR to append CARs' capability parameters to the CARD Reply in addition to address information, the MN must set this flag.

A-flag: Indicates that the requesting entity does NOT want the receiver of this message to perform reverse address translation. This flag is set if CARD protocol messages are piggybacked with a protocol that performs reverse address translation. For details, refer to Section 4.4 of this document.

T-flag: Indicates that the requesting entity is interested in obtaining all certificates from the responder. This flag is only valid on the AR-AR interface.

The flag combination A=1 and C=0 is invalid, and the flag T=1 is invalid on the MN-AR interface. The AR MUST discard an invalid message and log an appropriate error message.

Reserved:
Initialized to zero, ignored on receipt.

Sequence Number:
Allows requests to be correlated with replies.

Valid Sub-Options:

- L2 ID sub-option
- Preferences sub-option
- Requirements sub-option
- Trusted Anchor sub-option

To ensure that requirements on boundary alignment are met, individual sub-options MUST meet the 64-bit boundary alignment requirements respectively. This will ensure that the entire CARD Request option meets the 8n alignment constraint.

5.1.2.2. CARD Reply Option

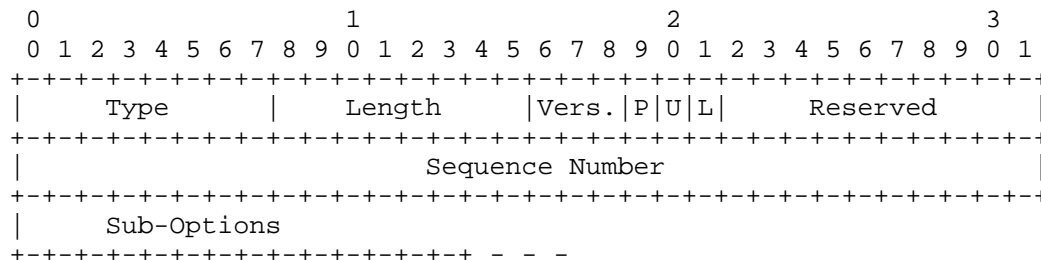

Fields:

Type: Assigned by IANA for IPv4 and IPv6 [Ke04].

Length: The length of the option in units of 8 octets, including the type and length fields as well as sub-options.

Vers.: 3-bit version code. For this specification, Vers.=1.

Flags: P-flag: Indicates the CARD-protocol message piggybacking capability of the CARD Reply message sender. A description for proper use of this flag can be found in Section 4.4 of this document.

U-flag: Indicates an unsolicited CARD Reply. This flag is only valid on the AR-AR interface.

L-flag: Set if this message is the last message in a multiple ICMP message reply. This flag is only valid on the MN-AR interface.

The flag U=1 on an AR-MN message is invalid. An invalid message should be discarded and an appropriate error message logged.

Reserved: Initialized to zero, ignored on receipt.

Sequence Number: Allows requests to be correlated with replies.

Valid Sub-Options:

- L2 ID sub-option
- Capability Container sub-option
- Address sub-option
- Router Certificate sub-option

To ensure requirements on boundary alignment are met, individual sub-options MUST meet 64-bit boundary alignment requirements respectively. This will ensure that the entire CARD Request option meets the 8n alignment constraint.

5.1.3. Sub-Options Format

All sub-options are of the following form:

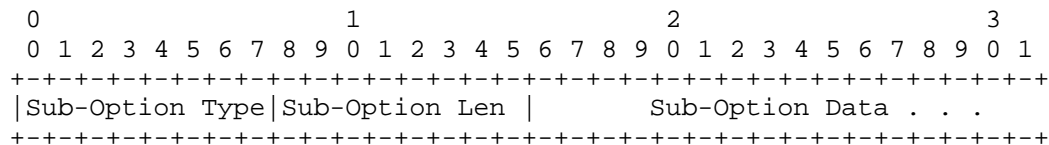

Sub-Option Type: 8-bit identifier of the type of option. The sub-options defined in this document are listed in the table below. The table also indicates on which interfaces the sub-option is valid.

Description	Type	Interface	
		/ MN-AR	\ AR-AR
L2 ID	0x01	x	
Address	0x02	x	
Capability Container	0x03	x	x
Preferences	0x04	x	x
Requirements	0x05	x	
Trusted Anchor	0x06	x	
Router Certificate	0x07	x	x

Sub-Option-Length: 8-bit unsigned integer indicating the length of the sub-option, including the sub-option type and sub-option length fields. Sub-option lengths are in units of 8 octets, aligned on a 64-bit boundary. Sub-options that are shorter are padded with null octets; the extent of the padding is determined by the sub-option contents.

5.1.3.1. L2 ID Sub-Option

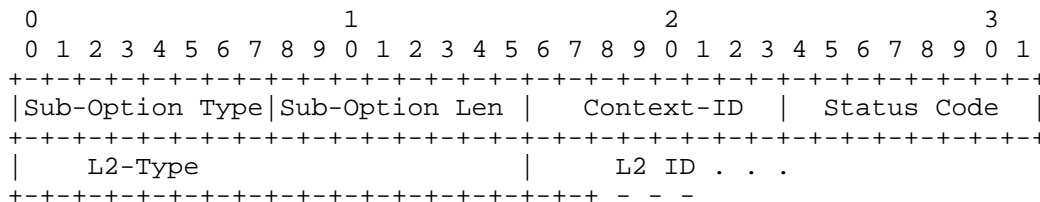

Sub-Option Type:
0x01

Sub-Option Length:
Length of the sub-option.

Context-ID: Associates the L2 ID, IP address and other parameters that belong to the same AR IP address but are encoded in separate sub-options.

Status Code: This field allows ARs to inform a requesting entity about processing results for a particular L2 ID. The L2 ID sub-option MUST be sent back to the requesting entity with a CARD Reply message.

The following status codes are specified:

- 0x00: NONE - This value MUST be set when the L2 ID is included in a CARD Request.
- 0x01: CANDIDATE - MUST be set in a CARD Reply when a L2 ID sub-option is included with information about candidate APs' L2 IDs. Candidate L2 IDs are sent if the CARD Request did not include a specific L2 ID for resolution. If CANDIDATE is set, the AR MUST set the Context-ID field of individual parameters to a value that allows associated L2 ID, address, and capability information to be matched on the receiver side.
- 0x02: MATCH - MUST be set in the CARD Reply to identify that this L2 ID matches previously resolved CAR information for a different L2 ID. If MATCH is set, the AR sets the Context-ID in the L2-ID sub-option to identify the matching previously resolved L2 ID.
- 0x03: RESOLVER ERROR - MUST be set in the CARD Reply if the L2 ID cannot be resolved. The AR sets this value for the Status Code in the returned L2 ID sub-option.

L2 type: Indicates the interface type. Allocated by IANA [Ke04].

L2 ID: The variable length Layer-2 identifier of an individual CAR's access point. The length without padding is determined by the L2 type.

5.1.3.2. Preferences Sub-Option

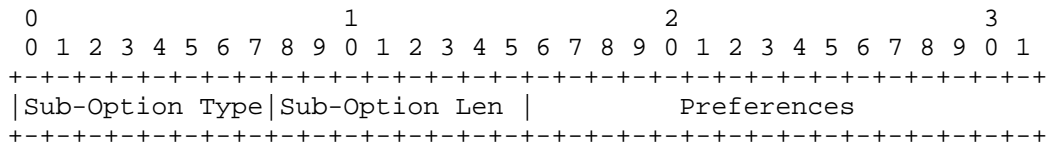

Sub-Option Type:
0x04

Sub-Option Length:
Length of the sub-option.

Preferences: List of capability attribute values (see Section 5.1.4).

Only ATTRIBUTE (AVP Code; see Section 5.1.4) fields MUST be present and set for individual capabilities, which are of interest to the requesting entity. The LIFETIME and VALUE (Data) indicator will not be processed and can be omitted. The AVP LENGTH indicator is also not present, as the preferences are indicated only with a list of 16-bit encoded ATTRIBUTE fields. If 64-bit boundary alignment requirements cannot be met with the list of ATTRIBUTE values, padding the missing 16-bit MUST be done with an ATTRIBUTE value of 0x0000. An ATTRIBUTE code of 0x0 is reserved so that the end of the ATTRIBUTE code list can be determined when an ATTRIBUTE value of 0x0 is read.

The use of the Preferences sub-option is optional and is for optimization purposes.

5.1.3.3. Requirements Sub-Option

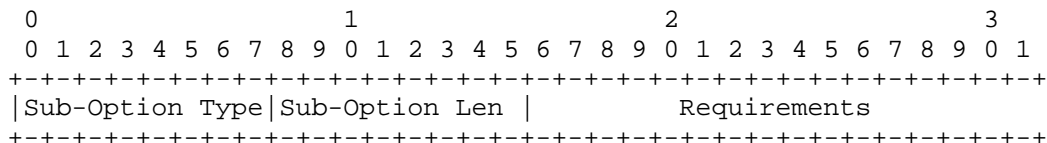

Sub-Option Type:
0x05

Sub-Option Length:
Length of the sub-option.

Requirements: AVP-encoded requirements (see Section 5.1.4)

AVPs MUST be encoded according to the rule described in Section 5.1.4. Both the ATTRIBUTE (AVP Code) and VALUE (Data) fields MUST be present and set appropriately. The end of the Requirements list can be determined when an ATTRIBUTE value of 0x0 is read.

The use of the Requirements sub-option is optional and is for optimization purposes.

5.1.3.4. Capability Container Sub-Option

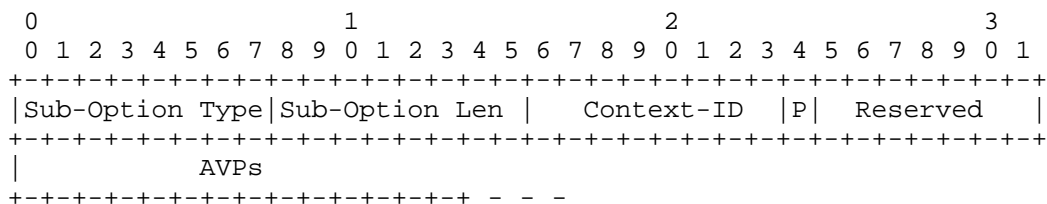

Sub-Option Type: 0x03

Sub-Option Length: Length of the sub-option.

Context-ID: Associates the L2 ID, IP address, and other parameters that belong to the same AR IP address but are encoded in separate sub-options.

Flags: P-flag: Indicates piggybacking capability of the CAR whose capabilities are conveyed in this Capability Container. This flag allows an MN to know after a CARD process whether a selected new AR can perform piggybacking.

Reserved: Initialized to zero, ignored on receipt.

AVPs: AVPs are a method of encapsulating capability information relevant for the CARD protocol. See Section 5.1.4 for the AVP encoding rule and list parsing.

5.1.3.5. Address Sub-Option

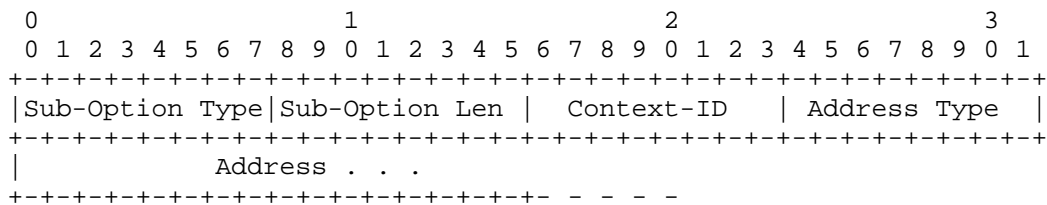

Sub-Option Type: 0x02

Sub-Option Length:

Length of the sub-option. For IPv4, the length is 1 (8 octets); for IPv6 the length is 3 (24 octets).

Context-ID:

Associates the L2 ID, IP address, and other parameters that belong to the same AR IP address but are encoded in separate sub-options.

Address Type:

Indicates the type of the address.

- 0x01 IPv4
- 0x02 IPv6

Address:

The Candidate Access Router's IP address.

5.1.3.6. Trusted Anchor Sub-Option

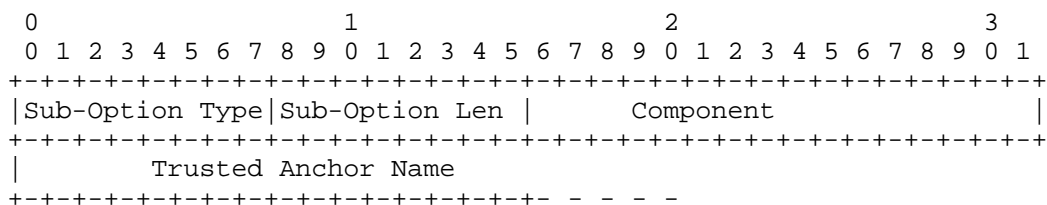

Sub-Option Type:

0x06

Sub-Option Length:

Length of the sub-option.

Reserved:

Initialized to zero, ignored on receipt.

Component:

A 2 octet unsigned integer field set to 65,535 if the sender desires to retrieve all the certificates in the certification path. Otherwise, it is set to the component identifier corresponding to the certificate that the receiver wants to retrieve.

Trusted Anchor Name:

DER encoding for the X.501 name of certification path component(see [Arkko04] for more detail on certification path component name encoding).

A CARD Request message containing Trusted Anchor sub-options MUST NOT contain any other sub-options, except for a single L2 ID sub-option identifying the AP of interest.

Trusted anchor sub-options SHOULD be retransmitted for individual components not received within CARD_REQUEST_RETRY seconds, rather than retransmitting a request for the whole list. Subsequent retransmissions SHOULD take into account any received options and only request those that have not been received.

5.1.3.7. Router Certificate Sub-Option

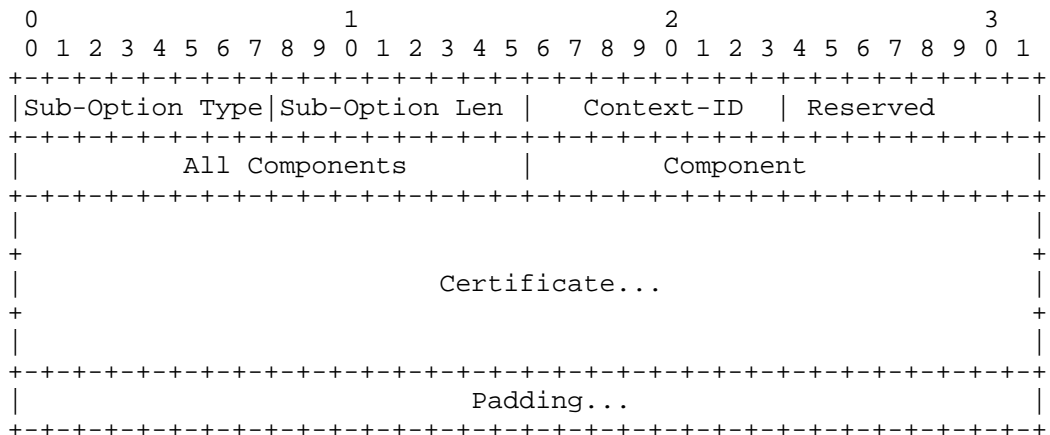

Sub-Option Type: 0x07

Sub-Option Length: Length of the sub-option.

Context-ID: Associates the L2 ID, IP address and other parameters that belong to the same AR IP address but are encoded in separate sub-options.

Reserved: Initialized to zero, ignored on receipt.

All Components: 2 octet unsigned integer giving the total number of certificates in the certification path.

Component: 2 octet unsigned integer giving the location of this certificate in the certification path.

Certificate: Variable-length field containing the X.509v3 router certificate encoded in ASN.1 (see [Arkko04] for more detail on a certificate profile that includes encoding).

Padding: Variable-length field making the option length a multiple of 8, beginning after the ASN.1 encoding of the certificate and continuing to the end of the option, as specified by the Length field.

A CARD Reply containing a Router Certificate sub-option MUST NOT include more than one such sub-option, and the CARD Reply MUST contain the matching L2 ID sub-option and router Address sub-option for the router possessing the chain with the Context-ID field set to a nonzero value, and with no other sub-options. Any other sub-options included in a CARD Reply SHOULD be ignored. If the reply spans multiple ICMP messages, the L2 ID sub-option and router Address sub-option MUST be included in the first message sent, and the Context-ID field in the Router Certificate sub-options in all the messages MUST be set to the same value as that in the L2 ID and Address sub-options. The replying AR SHOULD order the returned certification path so that the certificate immediately after the trust anchor in the path is the first certificate sent, in order to allow immediate verification. The trust anchor certificate itself SHOULD NOT be sent.

5.1.4. Capability AVP Encoding Rule

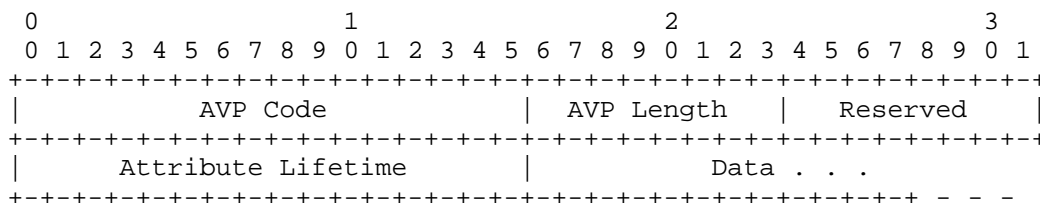

- AVP Code: Identifies the attribute uniquely. The AVP Code 0x0000 is reserved and MUST NOT be assigned to a capability.
- AVP Length: The 2 octet AVP length field indicates the number of octets in this AVP, including the AVP Code, AVP Length, Reserved, Lifetime, and Data fields.
- Reserved: Initialized to zero, ignored on receipt.
- Lifetime: Specifies the lifetime of the encoded capability in seconds. In the case of a static capability, the Lifetime field MUST be set to the maximum value (0xffff), which indicates that the lifetime of this capability parameter never expires. A lifetime value of 0x0000 deletes a capability entry.

Data: This variable-length field has the Value of the capability attribute encoded.

Because an AVP Code of 0x0 is reserved, it can be used by the sub-option list parsing to determine when the end of a list of Capabilities has been reached and where the sub-option padding starts. AVPs themselves are not zero padded.

Note: This document provides no detailed information on how to encode the individual capability attribute values, which is to be encoded in the Data field. Details on the interpretation of individual capability parameters are out of the scope of this document.

5.2. CARD Inter-Access Router Messages

5.2.1. AR-AR Transport

Because the types of access networks in which CARD might be useful are not currently deployed or, if they have been deployed, have not been extensively measured, it is difficult to know whether congestion will be a problem for inter-router CARD. Part of the research task in preparing CARD for consideration as a candidate for possible standardization is to quantify this issue. However, in order to avoid potential interference with production applications (should a prototype CARD deployment involve running over the public Internet), it seems prudent to recommend a default transport protocol that accommodates congestion.

This suggests that implementations of CARD MUST support and that prototype deployments of CARD SHOULD use the Stream Control Transport Protocol (SCTP) [Stew00] as the transport protocol between routers, especially if deployment over the public Internet is contemplated. SCTP supports congestion control, fragmentation, and partial retransmission based on a programmable retransmission timer. SCTP also supports many advanced and complex features, such as multiple streams and multiple IP addresses for failover, that are not necessary for experimental implementation and prototype deployment of CARD. The use of these SCTP features for CARD is not recommended at this time.

The SCTP Payload Data Chunk carries the CARD messages. CARD messages on the inter-router interface consist of just the CARD Request or CARD Reply options. The User Data part of each SCTP message contains the CARD option for the message type. For instance, a CARD Reply message is constructed by including the CARD Reply option and all the appropriate sub-options within the User Data part of an SCTP message.

A single stream is used for CARD with in-sequence delivery of SCTP messages. Each message, unless fragmented, corresponds to a single CARD query or response. Unsolicited CARD Reply messages can also be sent to peers to notify them of changes in network configuration or capabilities. A single stream provides simplicity. Use of multiple streams to prevent head-of-line blocking is for future study. Since timeliness is not an issue with inter-router CARD, and since there being more than one CARD transaction between two routers active at any one time is unlikely, having ordered delivery simplifies the implementation. The Payload Protocol Identifier in the SCTP header is 'CARD'. CARD uses the Seamoby SCTP port number [Ke04].

The format of Payload Data Chunk taken from [Stew00] is shown in the following diagram.

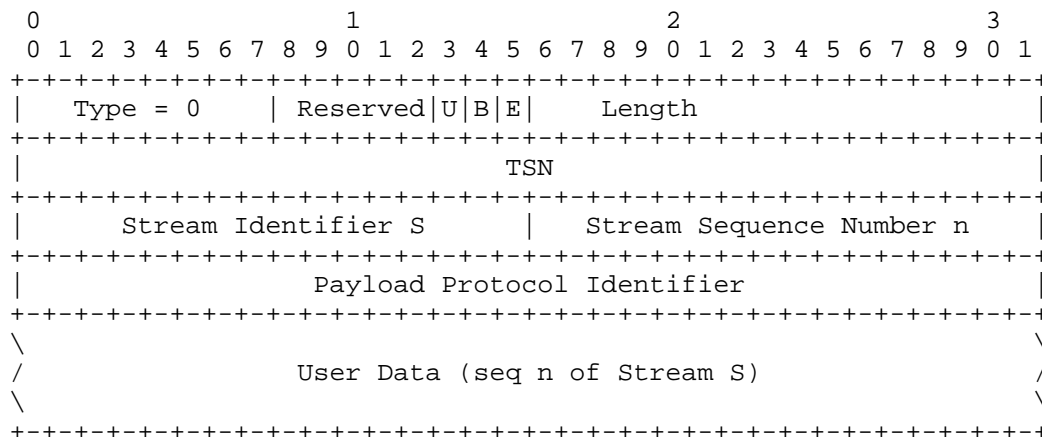

- 'U' bit The Unordered bit. MUST be set to 0 (zero).
- 'B' bit The Beginning fragment bit. See [Stew00].
- 'E' bit The Ending fragment bit. See [Stew00].
- TSN Transmission Sequence Number. See [Stew00].
- Stream Identifier S
 Identifies the CARD stream.
- Stream Sequence Number n
 Sequence number. See [Stew00].
- Payload Protocol Identifier
 Set to 'CARD'.
- User Data Contains the CARD message.

In order to avoid generating congestion on startup, ARs MUST wait a random amount of time between 0 and CARD_STARTUP_WAIT seconds upon reboot before sending an AR-AR CARD Request to one of its CARs. An AR that receives a CARD Request from another AR that is not in its CAR table MUST NOT solicit the AR but rather MUST wait until the AR sends an unsolicited CARD Reply advertising the AR's information. An AR that is starting up MUST send unsolicited CARD Replies to all its CARs to make sure that their CAR tables are properly populated.

The frequency of unsolicited CARD Reply messages MUST be strictly limited to CARD_MIN_UPDATE_INTERVAL, in order to avoid overwhelming CARs with traffic. ARs are free to discard messages that arrive more frequently.

If a CARD deployment will never run over the public Internet, and if it is known that congestion is not a problem in the access network, alternative transport protocols MAY be appropriate vehicles for experimentation. Implementations of CARD MAY support UDP for such purposes. In that case, the researcher MUST be careful to accommodate good Internet transport protocol engineering practices, such as using retransmits with exponential backoff. In addition, whether SCTP is an appropriate transport protocol for all inter-router CARD operations is an open research question. Investigation of this issue (for example, to determine whether a lighter-weight protocol might be more appropriate than SCTP) may be of interest to some researchers.

5.2.2. Protocol Payload Types

The AR-AR interface MUST insert the CARD Request option and CARD Reply option directly into the body of the SCTP User Data field. The sequence number for the CARD Request on the AR-AR interface MUST be initialized to zero when the AR reboots, and MUST be incremented every time a CARD Request message is sent. The replying AR MUST include a sequence number from the CARD Request in the CARD Reply. If an unsolicited CARD Reply is sent, the sending AR MUST increment the sequence number. Sequentially increasing sequence numbers allows the receiving AR to determine whether the information has already been received.

On the AR-AR interface, the Capability Container parameter is used to convey capabilities between ARs. Optionally, the Preferences parameter can be used for capability pre-filtering during the inter-AR capability discovery procedure. Payload types and encoding rules are the same as those described for the respective sub-option types in Section 5.1 for the MN-AR interface. The same TLV-encoded format is used to attach the options as payload to the protocol main header. Additionally, an AR can set the T flag in the CARD Request header in

order to obtain the certificates for the CAR. The description of sub-options in Section 5.1.3 includes information on what flag settings are prohibited on the AR-AR interface.

6. Security Considerations

6.1. Veracity of CARD Information

The veracity of the CARD protocol depends on the ability of an AR to obtain accurate information about geographically neighboring ARs, and to provide accurate information about its own APs and capabilities to other ARs. The CARD protocol described in the body of this document does not contain any support for determining the AR-to-AP mapping or capabilities, either for a specific AR or for a CAR. Therefore, methods for determining the accuracy of the information exchanged between ARs are out of scope for the base CARD protocol. The appendices of this document describe procedures for discovering the identities of the geographically adjacent ARs and APs (including capabilities) and discuss relevant security considerations. Alternatively, this information could be statically configured into the AR.

6.2. Security Association between AR and AR

CARD contains support allowing ARs to exchange capability information. If this protocol is not protected from modification, a malicious attacker can modify the information. Also, if the information is delivered in plain text, a third party can read it.

To prevent the information from being compromised, the CARD messages between ARs MUST be authenticated. The messages also SHOULD be encrypted for privacy of the information, if required. Confidentiality might be required if the traffic between two ARs in an operator's network traversed the public Internet, for example.

Two ARs engaging in the CARD protocol MUST use IKE [HarCar98] to negotiate an IPsec ESP security association for message authentication. If confidentiality is desired, the two ARs MUST additionally negotiate an ESP security association for encryption. Replay protection SHOULD also be enabled with IKE. To protect CARD protocol messages between ARs, IPsec ESP [AtKe98] MUST be used with a non-null integrity protection and origin authentication algorithm and SHOULD be used with a non-null encryption algorithm for protecting the confidentiality of the CARD information.

An AR can provide the certificates for its CARs if the certificates are available. The AR requests certificates from its CARs by setting the T flag in the CARD Request message. All certificates are sent.

If CARD is used to exchange information between different administrative domains, additional security policy issues may apply. Such issues are out of the scope of this document. Use of CARD between administrative domains is not recommended at this time, until the policy issues involved are more thoroughly understood.

6.3. Security Association between AR and MN

A malicious node can send bogus CARD Reply messages to MNs by masquerading as the AR. The MN MUST authenticate the CARD Reply messages from the AR. Since establishing an IPSec security association between the MN and AR is likely to be a performance issue, IKE is not an appropriate mechanism for setting up the security association. Instead, the SEND security association is used [Arkko04]. ARs MUST include a SEND Signature Option on CARD Reply messages. The format of the signature option is the same for both IPv4 and IPv6 CARD, though SEND itself is only defined for IPv6. A Mobile IPv4 ICMP Foreign Agent Advertisement option type code for the SEND signature option [Ke04] has been allocated.

No authentication is required for CARD Requests since CARD information is provided by the AR to optimize link access. In contrast, CARD Reply authentication is required because a bogus AR could provide the MN with CARD information that would lead the MN to handover to a bogus router, which could steal traffic or propagate a denial of service attack on the MN. The asymmetry of the authentication requirement is the same as that involving Router Advertisements in IPv6 router discovery [Arkko04].

Since CARD is a discovery protocol, confidentiality is not generally necessary on the MN-AR interface. In specific cases where different network operators share the same access network infrastructure, network operators may want to hide information about operator-specific capabilities for business reasons. The base CARD protocol contains no support for such cases. However, should such a case arise in the future, an AVP for an encrypted capability can be defined at that time.

6.4. Router Certificate Exchange

Because SEND is only available in IPv6, the procedures for obtaining certificates differ depending on whether CARD is used with IPv4 or IPv6. In IPv6, when the MN receives a CARD reply with signature from an AR for which it does not have a certificate, it SHOULD use SEND DCS/DCA to obtain the AR's certificate chain. ARs MUST be configured with a certification path for this purpose, and MNs MUST be configured with a set of certificates for shared trusted anchors to allow verification of the AR certificates. An MN may not necessarily

need to use Cryptographically Generated Addresses (CGAs) with CARD, so CGA support is OPTIONAL for CARD. A certificate profile for ARs is described in the SEND specification [Arkko04].

In IPv4, there is no DCS/DCA message for obtaining the certificate. If the MN does not have a certificate for the AR, the MN sends a CARD Request message containing the L2 ID of its current AP and one Trusted Anchor sub-option (Section 5.1.3.6) for each shared trusted anchor for which the MN has a certificate, to obtain the certification path for the current AR. The Component field of the Trusted Anchor sub-option is set to 65535 to indicate that the entire certification path is needed. No other options should be included in the request. The AR replies by sending a CARD Reply containing the L2 ID sub-option sent in the request, an Address sub-option for itself, and a Router Certificate sub-option (Section 5.1.3.7) containing one certificate in its certification path that matches one of the requested trust anchors, and no other sub-options, setting the Context-ID of all sub-options to match. The All Components field is set to the path length, and the Component field is set to the number of this component in the path. If the path is longer than one certificate, the AR sends the L2 ID sub-option and the Address sub-option in the first certificate and the other certificates in separate ICMP messages, due to the limitation on ICMP message length, with the same Context-ID set on each Route Certificate sub-option, and with the Component field properly set. The router SHOULD NOT send the trusted anchor's certificate and SHOULD send certificates in order from the certificate after the trusted anchor. If the trusted anchor option does not match any certificate, the AR returns the Trusted Anchor sub-options in the reply. The MN SHOULD immediately conduct a Certificate Revocation List (CRL) check on any certificates obtained through CARD certificate exchange, to make sure that the certificates are still valid.

Certification paths for CARs may be fetched in advance of handover by requesting them as part of the CARD protocol. In that case, the MN includes Trusted Anchor sub-options in the CARD request along with the L2 ID sub-option for the AP for which the CAR certificate is desired, and the AR replies as above, except that the L2 ID, address, and certificates are for the CAR instead of for the AR itself. This allows the MN to skip the DCS/DCA or CARD certificate exchange when it moves to a new router.

Because the amount of space in an ICMP message is limited, the router certification paths SHOULD be kept short.

6.5. DoS Attack

An AR can be overwhelmed with CARD Request messages. The AR SHOULD implement a rate-limiting policy so that it does not send or process more than a certain number of messages per period. The following is a suggested rate limiting policy. If the number of CARD messages exceeds `CARD_REQUEST_RATE`, the AR SHOULD begin to drop messages randomly until the rate is reduced. MNs SHOULD avoid sending messages more frequently than `CARD_REQUEST_RATE`. ARs SHOULD also avoid sending unsolicited CARD Replies or CARD Requests more frequently than `CARD_MIN_UPDATE_INTERVAL`, but, in this case, the existence of an IPsec security association ensures that messages from unknown entities will be discarded immediately during IPsec processing.

MNs MUST discard CARD Replies for which there is no outstanding CARD Request, as indicated by the sequence number.

6.6. Replay Attacks

To protect against replay attacks on the AR-AR interface, ARs SHOULD enable replay protection when negotiating the IPsec security association using IKE.

On the MN-AR interface, the MN MUST discard any CARD Replies for which there is no outstanding request, as determined by the sequence number. For ARs, an attacker can replay a previous request from an MN, but the attack is without serious consequence because the MN ignores the reply in any case.

7. Protocol Constants

Constant	Section	Default Value	Meaning
<code>CARD_REQUEST_RETRY</code>	5.1.1	2 seconds	Wait interval before initial retransmit on MN-AR interface.
<code>CARD_RETRY_MAX</code>	5.1.1	15 seconds	Give up on retry on MN-AR interface.
<code>CARD_STARTUP_WAIT</code>	5.2.1	1-3 seconds	Maximum startup wait for an AR before performing AR-AR CARD.
<code>CARD_MIN_UPDATE_INTERVAL</code>	5.2.1	60 seconds	Minimum AR-AR update interval.

CARD_REQUEST_RATE	6.5	2 requests/ sec.	Maximum number of messages before AR institutes rate limiting.
-------------------	-----	---------------------	---

8. IANA Considerations

See [Ke04] for instructions on IANA allocation.

9. Normative References

- [Brad97] Bradner, S., "Key words for use in RFCs to Indicate Requirement Levels", BCP 14, RFC 2119, March 1997.
- [Stew00] Stewart, R., Xie, Q., Morneault, K., Sharp, C., Schwarzbauer, H., Taylor, T., Rytina, I., Kalla, M., Zhang, L., and V. Paxson, "Stream Control Transmission Protocol", RFC 2960, October 2000.
- [AtKe98] Kent, S. and R. Atkinson, "IP Encapsulating Security Payload (ESP)", RFC 2406, November 1998.
- [HarCar98] Harkins, D. and D. Carrel, "The Internet Key Exchange (IKE)", RFC 2409, November 1998.
- [Arkko04] Arkko, J., Kempf, J., Zill, B., and P. Nikander, "SEcure Neighbor Discovery (SEND)", RFC 3971, March 2005.
- [Ke04] Kempf, J., "Instructions for Seamoby and Experimental Mobility Protocol IANA Allocations", RFC 4065, July 2005.

10. Informative References

- [TKCK02] Trossen, D., Krishnamurthi, G. Chaskar, H., Kempf, J., "Issues in candidate access router discovery for seamless IP-level handoffs", Work in Progress.
- [MaKo03] Manner, J. and M. Kojo, "Mobility Related Terminology", RFC 3753, June 2004.
- [Kood03] Koodli, R., Ed., "Fast Handovers for Mobile IPv6", RFC 4068, July 2005.
- [Funa02] Funato, D., et al., "Geographically Adjacent Access Router Discovery Protocol", Work in Progress.

- [Tros03] Trossen, D., et al., "A Dynamic Protocol for Candidate Access-Router Discovery", Work in Progress.
- [ShGi00] Shim, E. and R. Gitlin, "Fast Handoff Using Neighbor Information", Work in Progress.
- [Malk03] El Malki, K., et al., "Low Latency Handoffs in Mobile IPv4", Work in Progress.

11. Contributors

The authors would like to thank Vijay Devarapalli (Nokia) and Henrik Petander (Helsinki University of Technology) for formally reviewing the protocol specification document and providing valuable comments and input for technical discussions. The authors would also like to thank James Kempf for reviewing and for providing a lot of valuable comments and editing help.

12. Acknowledgements

The authors would like to thank (in alphabetical order) Dirk Trossen, Govind Krishnamurthi, James Kempf, Madjid Nakhjiri, Pete McCann, Rajeev Koodli, Robert C. Chalmers, and other members of the Seamoby WG for their valuable comments on the previous versions of the document, as well as for the general CARD-related discussion and feedback. In addition, the authors would like to thank Erik Nordmark for providing valuable insight about the piggybacking of CARD options upon Fast Mobile IPv6 messages.

Appendix A. Maintenance of Address Mapping Tables in Access Routers

This appendix provides information on two optional CAR table maintenance schemes for reverse address mapping in access routers. These schemes replace static configuration of the AP L2 ID-to-CAR IP address mapping in the CAR table. Details on these mechanisms are out of the scope of this document. The intention of this appendix is to provide only a basic idea on flexible extensions to the CARD protocol, as described in this document.

Appendix A.1. Centralized Approach Using a Server Functional Entity

The centralized approach performs CARD over the MN-AR interface as described in Section 4 of this document. Additionally, the centralized approach introduces a new entity, the CARD server, to assist the current AR in performing reverse address translation. The centralized approach requires that neighboring ARs register with the CARD server to populate the reverse address translation table. The registration of AR addresses with the CARD server is performed prior to initiation of any reverse address translation request.

Figure A.1 illustrates a typical scenario of the centralized CARD operation. In this example, ARs have registered their address information with a CARD server in advance. When an MN discovers the L2 ID of APs during L2 scanning, it passes one or more L2 IDs to its current AR, and the AR resolves them to the IP address of the AR. For this, the AR first checks whether the mapping information is locally available in its CAR table. If it is not, the MN's current AR queries a CARD server with the L2 ID. In response, the CARD server returns the IP address of the CAR to the current AR. Then, the current AR directly contacts the respective CAR and performs capability discovery with it. The current AR then passes the IP address of the CAR and associated capabilities to the MN. The current AR then stores the resolved IP address within its local CAR table. The centralized CARD protocol operation introduces additional signaling messages, which are exchanged between the MN's current AR and the CARD server. The signaling messages between an AR and the CARD server function are shown with the preceding identifier "AR-Server", referring to the associated interface.

An initial idea of performing reverse address translation using a centralized server is described in [Funa02].

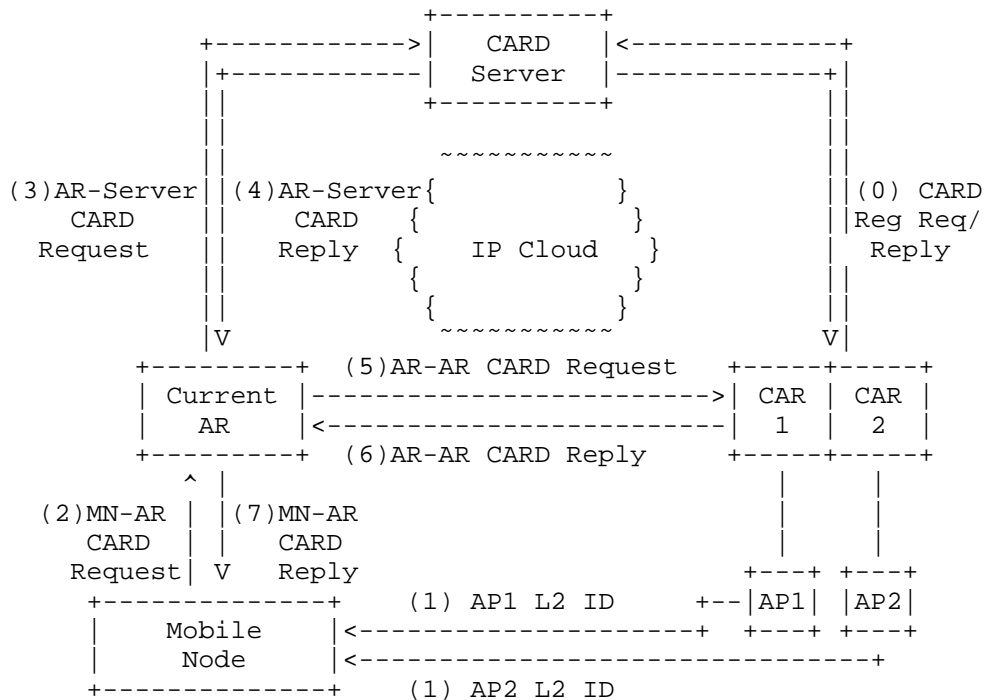

Figure A.1: Centralized Approach for L2-L3 Mapping

Appendix A.2. Decentralized Approach Using Mobile Terminals' Handover

This approach performs CARD over the MN-AR interface as described in Section 4. However, it employs one additional message, called the Router Identity message, over the MN-AR interface to enable ARs to learn about the reverse address translation tables of their neighboring ARs, without being dependent on any centralized server.

In this approach, CAR identities in the CAR table of an AR are maintained as soft state. The entries for CARs are removed from the CAR table if they are not refreshed before the timeout period expires and are created or refreshed according to the following mechanism.

The key idea behind the decentralized approach is to bootstrap and maintain the association between two ARs as neighbors of each other using the actual handover of MNs occurring between them as input. The first handover between any two neighboring ARs serves as the bootstrap handover to invoke the discovery procedure, and the subsequent handover serves to refresh the association between the neighboring ARs. After the bootstrap handover, the MNs can perform

CARD and thus seamless handover using the CAR information. This idea was presented in [ShGi00] and [Tros03].

Maintenance of the CAR table is done by using an additional option for the CARD protocol operation performed between an MN and its current AR. This message serves as Router Identity message.

Upon the completion of an inter-AR handover, the MN SHOULD send a Router Identity message to its current AR. This message contains the identity (IP address) of the previous AR (pAR), and can be sent as a specific sub-option in the MN-AR CARD Request message. It SHOULD be acknowledged with the MN-AR CARD Reply. The Router Identity message enables the MN's current AR to learn that the pAR (still) has an AP whose coverage overlaps with one of the APs of the current AR, and vice versa. With this information, the MN's current AR can create or refresh an entry for the pAR as its neighbor. If handover is no longer possible between two ARs, the associated entries eventually timeout and are removed from each AR's CAR table.

Prior to trusting the MN's report, however, the current AR may perform a number of checks to ensure the validity of the received information. One simple method is to verify the accuracy of the Router Identity message by sending an AR-AR CARD Request message to the pAR. The AR-AR CARD Request includes the identity of the MN. Upon receiving this message, the pAR verifies that the MN was indeed attached to it during a reasonable past interval and responds to the current AR. In this way, each handover of a MN results in a bi-directional discovery process between the two participating ARs.

Upon receiving a positive verification response, the current AR creates or refreshes, as applicable, the entry for the pAR in its local CAR table. In the former case, the current AR and the pAR exchange capabilities using the AR-AR CARD Request and AR-AR CARD Reply protocol messages. When a new entry is created, the ARs MUST exchange their reverse address translation tables. They may exchange other capabilities at this time or may defer exchange to a later time when some MN undergoing handover between them performs CARD as described in Section 4. In the latter (refresh) case, ARs may exchange capabilities or defer exchanges until a later time when another MN undergoes handover.

Finally, note that in a handover-based protocol, a first handover between a pAR and an MN's current AR cannot use CARD, as this handover bootstraps the CAR table. However, in the long term, such a handover will only amount to a small fraction of total successful handover between the two ARs. Also, if the MN engaging in such a first handover is running a non-delay sensitive application at the time of handover, the user may not even realize its impact.

Appendix B. Application Scenarios

This section provides two examples of application scenarios for CARD protocol operation. One scenario describes a CARD protocol operation in a Mobile IPv6 (MIPv6) network, providing access to the infrastructure via wireless LAN Access Points and associated Access Routers. A second scenario describes CARD protocol operation in a Mobile IPv6-enabled network, which has enhanced support for fast handover integrated (Fast Mobile IPv6), also providing wireless LAN access to the infrastructure.

This application scenario assumes a moving MN having access to the infrastructure through wireless LAN (IEEE802.11) APs. Mobility management is performed using the Mobile IPv6 protocol. The following figure illustrates the assumed access network design.

Appendix B.1. CARD Operation in a Mobile IPv6-Enabled Wireless LAN Network

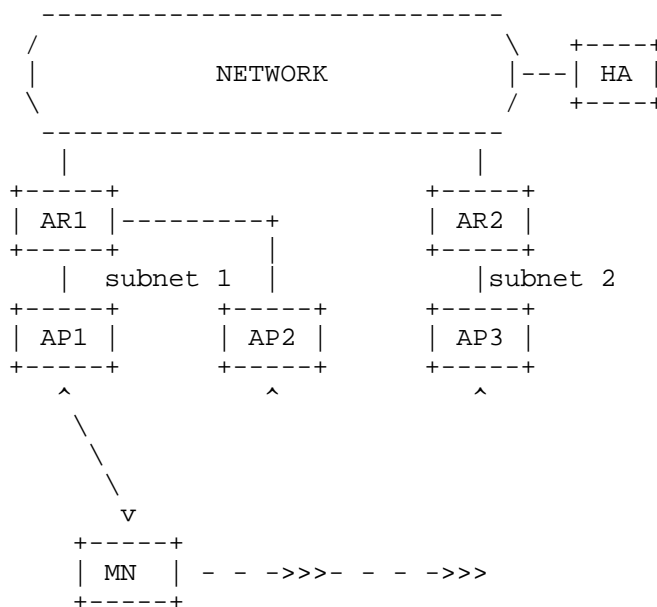

Figure B.1: Assumed Network Topology

A Mobile IPv6 Home Agent (HA) maintains location information for the MN in its binding cache. In Figure B.1, the MN holds a care-of address for the subnet 1, supported by AR1. As the MN moves, the MN's current environment offers two further wireless LAN APs with increasing link-quality as candidate APs for a handover. To

facilitate decision making, parameters associated with ARs are taken into account during the decision process. The AR-related parameters can be, for example, available QoS resources or the type of access technologies supported from an AR. To learn about these candidate ARs' capabilities and associated IP address information, the MN performs CARD. This requires retrieving information about candidate APs' L2 IDs. Furthermore, associated link-quality parameters are retrieved to ascertain whether approaching APs are eligible candidates for a handover. If AP2 and AP3 are suitable candidate APs, the MN encapsulates both L2 IDs (AP2 and AP3) into a CARD Request message, using the L2 ID sub-option, and sends the message to its current AR (AR1).

AR1 resolves each L2 ID listed in L2 ID options to the associated IP address of the respective CAR, making use of its local CAR table. According to the environment illustrated in Figure B.1, the associated AR IP address of the candidate AP2 will be the same as the MN is currently attached to, which is AR1. The corresponding IP address of the candidate AR, to which AP3 is connected, is the address of AR2. IP addresses of the MN's CARs are now known to AR1, which retrieves the CARs' capabilities from the CAR table. Assuming that it has valid entries for respective capability parameters to refresh dynamic capabilities, whose associated lifetimes in AR1's CAR table have expired, AR1 performs Inter-AR CARD for capability discovery. Since capability information for AR1 is known to AR1, a respective Inter-AR CARD Request is sent only to AR2. In response, AR2 sends a CARD Reply message back to AR1, encapsulating the requested capability parameters with the signaling message in a Capability Container sub-option.

Next, AR1 sends its own capabilities and the dynamically discovered ones of AR2 back to the MN via a CARD Reply message. Furthermore, AR1 stores the capability parameters of AR2 with the associated lifetimes in its local CAR table.

Upon receipt of the CARD Reply message, the MN performs target AR selection, taking AR1's and AR2's capability parameters and associated APs' link-quality parameters into account. If the selected AP is AP2, no IP handover needs to be performed. If AP3 and the associated AR2 are selected, the MN needs to perform an IP handover according to the Mobile IPv6 protocol operation.

Figure B.2 illustrates the signaling flow of the previously described application scenario of CARD within a Mobile IPv6-enabled network.

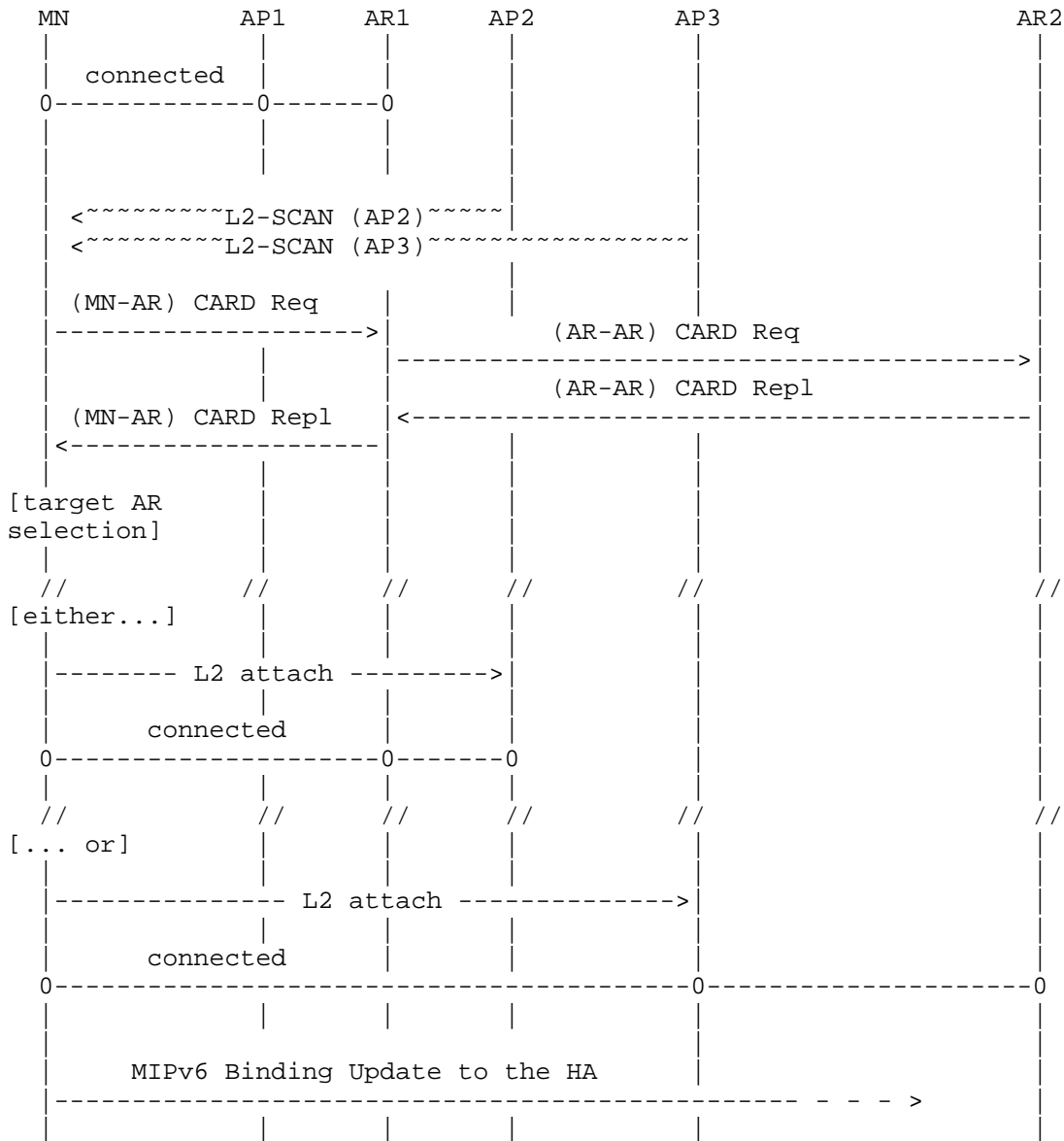

Figure B.2. CARD Protocol Operation within a Mobile IPv6-Enabled Wireless LAN Network

Appendix B.2. CARD Operation in a Fast Mobile IPv6 Network

This application scenario assumes that ARs can perform the fast handover protocol sequence for Mobile IPv6 [Kood03]. The MN scans for new APs for handover, similar to Figure B.1. To discover the ARs (CARs), the MN attaches a MN-AR CARD Request option to the ICMP-type Fast Mobile IPv6 RtSolPr message, which is sent to the MN's current AR (pAR, previous AR).

Candidate APs' L2 IDs are encapsulated using the CARD protocol's L2 ID sub-options, which allow the MN to send multiple L2 IDs of candidate APs to its current AR. (This potentially replaces the "New Attachment Point Link-Layer Address" option of the Fast Mobile IPv6 protocol.)

The pAR resolves the received list of candidate APs' L2 IDs to the IP addresses of associated CARs. The pAR checks its local CAR table to retrieve information about the CARs' capabilities. If any table entries have expired, the pAR acquires this CAR's capabilities by sending an AR-AR CARD Request to the respective CAR. The CAR replies with an AR-AR CARD Reply message, encapsulating all capabilities in a Capability Container sub-option and attaching them to the CARD Reply option. On receipt of the CARs' capability information, the pAR updates its local CAR table and forwards the address and capability information to the MN by attaching a MN-AR CARD Reply option to the Fast Mobile IPv6 PrRtAdv message. When the MN's handover is imminent, the MN selects its new AR and the associated new AP from the discovered list of CARs. According to the Fast Mobile IPv6 protocol, the MN notifies the pAR of the selected new AR with the Fast Binding Update (F-BU) message, allowing the pAR to perform a fast handover according to the Fast Mobile IPv6 protocol.

Optionally, the pAR could perform selection of an appropriate new AR on behalf of the MN after the pAR has the MN's CARs' addresses and associated capabilities available. The MN must send its requirements for the selection process to its pAR together with the MN-AR CARD Request message. After the pAR has selected the MN's new AR, the address and associated capabilities of the chosen new AR are sent to the MN with the CARD Reply option in the Fast Mobile IPv6 PrRtAdv message.

Figure B.3 illustrates how CARD protocol messages and functions work with the Fast Mobile IPv6 protocol.

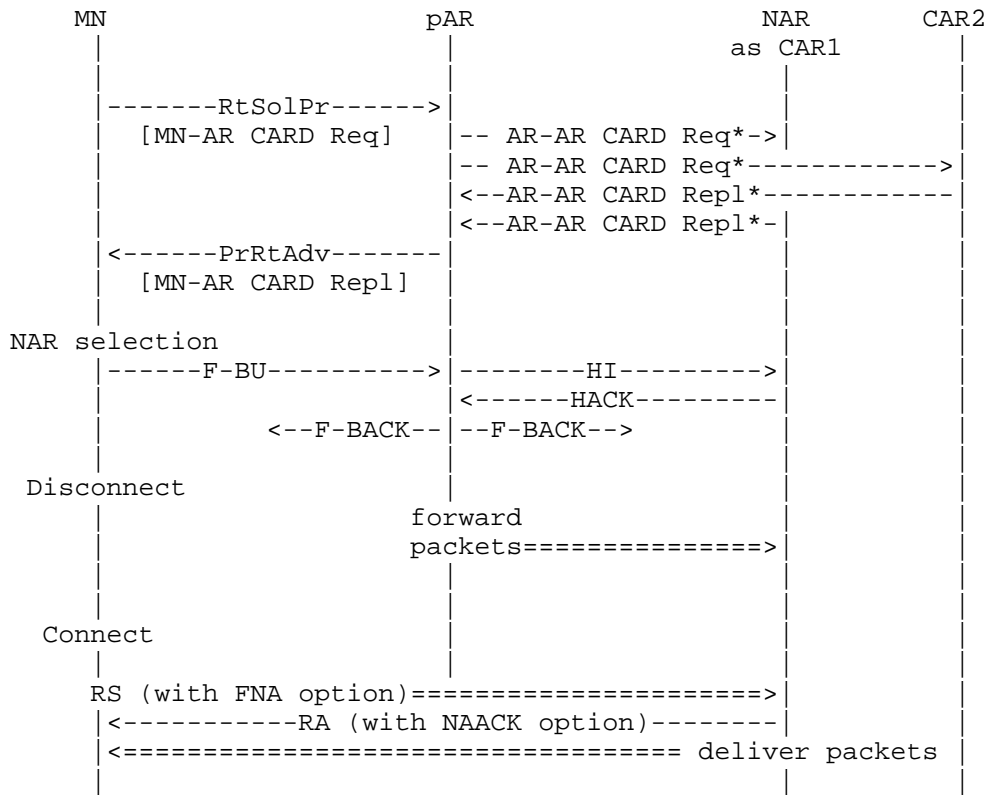

Figure B.3. Fast Handover Protocol Sequence with CARD Protocol Options

* In Figure B.3, the CARD protocol interaction between the pAR and CARs is only required if the lifetime of any capability entries in the pAR's CAR table have expired. Otherwise, the pAR can respond to the requesting MN immediately after retrieving the CARs' addresses and capability information from its CAR table.

Authors' Addresses

Hemant Chaskar
AirTight Networks
339 N. Bernardo Avenue
Mountain View, CA 94043, USA

EMail: hemant.chaskar@airtightnetworks.net

Daichi Funato
NTT DoCoMo, Inc.
Communication Systems Laboratory
Wireless Laboratories
3-5, Hikarinooka, Yokosuka,
Kanagawa 239-8536, Japan

Phone: +81-46-840-3921
EMail: funato@mlab.yrp.nttdocomo.co.jp

Marco Liebsch
NEC Network Laboratories
Kurfuersten-Anlage 36,
69115 Heidelberg, Germany

Phone: +49 6221-90511-46
EMail: marco.liebsch@netlab.nec.de

Eunsoo Shim
Panasonic Digital Networking Laboratory
Panasonic Corporation
Two Research Way
Princeton, NJ 08540

Phone: +1-609-734-7354
EMail: eunsoo@research.panasonic.com

Ajoy Singh
Motorola Inc
2G11, 1501 West Shure Dr.
Arlington Heights, IL 60004, USA

Phone: +1 847-632-6941
EMail: asingh1@email.mot.com

Full Copyright Statement

Copyright (C) The Internet Society (2005).

This document is subject to the rights, licenses and restrictions contained in BCP 78, and except as set forth therein, the authors retain all their rights.

This document and the information contained herein are provided on an "AS IS" basis and THE CONTRIBUTOR, THE ORGANIZATION HE/SHE REPRESENTS OR IS SPONSORED BY (IF ANY), THE INTERNET SOCIETY AND THE INTERNET ENGINEERING TASK FORCE DISCLAIM ALL WARRANTIES, EXPRESS OR IMPLIED, INCLUDING BUT NOT LIMITED TO ANY WARRANTY THAT THE USE OF THE INFORMATION HEREIN WILL NOT INFRINGE ANY RIGHTS OR ANY IMPLIED WARRANTIES OF MERCHANTABILITY OR FITNESS FOR A PARTICULAR PURPOSE.

Intellectual Property

The IETF takes no position regarding the validity or scope of any Intellectual Property Rights or other rights that might be claimed to pertain to the implementation or use of the technology described in this document or the extent to which any license under such rights might or might not be available; nor does it represent that it has made any independent effort to identify any such rights. Information on the procedures with respect to rights in RFC documents can be found in BCP 78 and BCP 79.

Copies of IPR disclosures made to the IETF Secretariat and any assurances of licenses to be made available, or the result of an attempt made to obtain a general license or permission for the use of such proprietary rights by implementers or users of this specification can be obtained from the IETF on-line IPR repository at <http://www.ietf.org/ipr>.

The IETF invites any interested party to bring to its attention any copyrights, patents or patent applications, or other proprietary rights that may cover technology that may be required to implement this standard. Please address the information to the IETF at ietf-ipr@ietf.org.

Acknowledgement

Funding for the RFC Editor function is currently provided by the Internet Society.