

**CBM<sup>TM</sup>**

**CBM<sup>TM</sup>**

**CBM<sup>TM</sup>**

**CBM<sup>TM</sup>**

**PRINTER**

**PRINTER**

**PRINTER**

**PRINTER**

**CBM PRINTER OPERATOR GUIDE**  
**MODEL 8024**

# COMMODORE CBM PRINTER, MODEL 8024

## OPERATOR GUIDE

The information in this manual has been reviewed and is believed to be entirely reliable. No responsibility, however, is assumed for inaccuracies. The material in this manual is for information purposes only, and is subject to change without notice.

**Commodore Business Machines**  
3330 Scott Boulevard  
Santa Clara, California 95050

P/N 640108  
REV. B  
NOV. 1981

# Table of Contents

|   | Page No. |
|---|----------|
| INTRODUCTION .....                                | 3        |
| GENERAL INFORMATION .....                         | 3        |
| SPECIFICATIONS .....                              | 5        |
| INSTALLATION/PAPER AND RIBBON LOADING .....       | 7        |
| Installation Instructions .....                   | 7        |
| Paper Loading .....                               | 8        |
| Ribbon Changing .....                             | 9        |
| CONTROLS/INDICATORS .....                         | 10       |
| CONTROLS .....                                    | 10       |
| AC Power ON/OFF .....                             | 10       |
| Print ON/OFF .....                                | 10       |
| Form Feed / Line Feed .....                       | 11       |
| Forms Thickness Control .....                     | 11       |
| Form Width Control .....                          | 12       |
| 6/8 Lines per Inch Vertical Format Controls ..... | 12       |
| Self-Test .....                                   | 13       |
| INDICATORS .....                                  | 14       |
| Power On .....                                    | 14       |
| Print .....                                       | 14       |
| Paper Out .....                                   | 14       |
| OPERATING INSTRUCTIONS .....                      | 15       |
| Audio Alarm .....                                 | 15       |
| Using the 8024 Printer .....                      | 15       |
| SELF-TEST PROCEDURES .....                        | 15       |
| SETTING LINE SPACING .....                        | 16       |
| OPTIONS .....                                     | 17       |
| IEEE-488 INTERFACE .....                          | 29       |
| CONTROL CODE SUMMARY .....                        | 36       |
| PROGRAMMING .....                                 | 38       |

## **INTRODUCTION**

This operator's guide includes information and instructions for daily operation of the 8024 printer. Other than routine cleaning and ribbon changing no preventive maintenance is required. Detailed service and interface information is available in the model 8024 – Maintenance Manual.

## **GENERAL INFORMATION**

The 8024 serial printer prints 160 characters per second bidirectionally. In bidirectional printing, the print head prints a line in a given direction, moves to the nearest end of the next line to be printed, and prints that line in the opposite direction, thereby increasing overall printing efficiency. Up to 132 characters can be printed on one line. The standard printer is programmed for a form 11 inches long (either 6 or 8 lines per inch).

Paper movement is controlled to and from the platen by two dual tractors which adjust to accommodate varying paper widths. The printers use a 66-line counter to control form feed commands for the 11-inch form. When the printer is out of paper, a sensor switch activates the audible alarm, the PAPER OUT indicator. The printer cannot be enabled when out of paper.

An inked fabric ribbon is contained in a replaceable cartridge which easily snaps into place over two guide pins and the ribbon motor drive shaft. The continuous loop ribbon is driven by a non-reversing motor. The ribbon life is sufficient to print two million characters in a shifting 96-character pattern on single part 15 pound bond paper.

The electronics are designed around a self-contained microprocessor which simplifies the remaining circuitry. Read/write memories store up to 132 printable characters supplied to the input before printing a line.

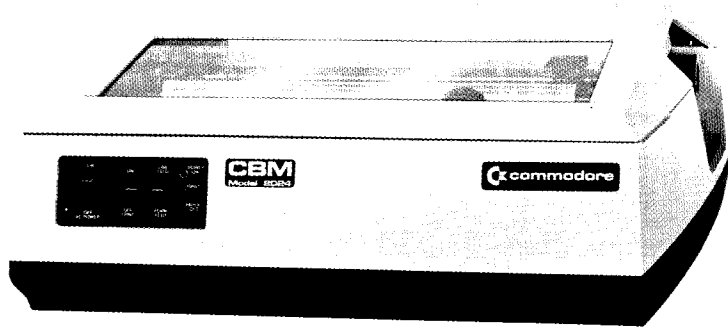

## **COMMODORE CBM PRINTER, MODEL 8024**

# SPECIFICATIONS

|                                     |  |
|-------------------------------------|--|
| Printing Rate:                      | 160 characters per second  |
| Single Line Paper Advance:          | 70 milliseconds maximum  |
| Multiple Line Paper Advance (slew): | 8 inches per second minimum  |
| Number of Columns:                  | 132  |
| Character Spacing:                  | 10 characters per inch   |
| Line Spacing:                       | 6 or 8 lines per inch  |
| Horizontal Column Displacement:     | $\pm$ .003 inch, any two characters<br>$\pm$ .01 inch, between 10 columns  |
| Character Style:                    | 7 x 7 half space   |
| Option:                             | 9 x 7 half space   |
| Character Size:                     | 0.080 inch wide, 0.106 inch high   |
| Character Set:                      | 96 character ASCII, U/L case (European National Character set on request)  |
| Environment:                        | Operating Temperature: 10°C to 38°C (50°F to 100.4°F)<br>Humidity: 10 to 90% relative humidity, noncondensing  |
| Storage Temperature:                | -20°C to +60°C (-4°F to +140°F)  |
| Altitude:                           | -91.44 m to +15,240 m (-300 ft. to +50,000 ft.)  |
| Paper:                              | Original and up to four copies of standard continuous fanfold paper forms 4 to 15 inches wide and 3 to 17 inches long  |
| Marginal sprocket holes:            | .160 inch diameter with .500 inch spacing  |
| Acceptable Paper Weights:           | Original only – 12 to 20 lb. bond (.0024 to .0040 inch typical thickness)<br><br>Original and up to 3 copies – 11/2 to 20 lb. bond (.0020 to .0040 inch typical thickness)<br><br>8 lb. carbons (.0011 inch typical thickness)<br><br>Original and up to 5 copies – 11/2 lb. bond (.0020 inch typical thickness)<br><br>8 lb. carbons (.0011 inch typical thickness) |

|                              |  |
|------------------------------|--|
| Paper Feed:                  | Two dual tractors adjustable to fit varying paper width  |
| Inking System:               | Continuous loop, non-reversing, cartridge, fabric ribbon   |
| Special Features:            | Double-Width Character<br>6/8 Lines per Inch<br>Self-Test  |
| Power Requirements:          | Input – 200 Watts maximum  |
| Line Voltage Options:        | 90–132 VAC 60 Hz $\pm$ 2%<br>187–264 VAC 50 Hz $\pm$ 2%  |
| Maximum Physical Dimensions: | Width – 25.5 inches<br>Depth – 19.5 inches<br>Height – 8.7 inches (23.62 inches with cover open)<br>Weight – 64 pounds |

## **Ribbon Cartridge**

Replaceable cartridge: (Two Million Character Life) Minimum order of 10.

# INSTALLATION/PAPER AND RIBBON LOADING

## INSTALLATION INSTRUCTIONS

### CAUTION

The following instructions must be performed prior to applying power to the printer.

- Open cover lid.
- Remove carriage packing.
- Close cover lid.
- Remove the shipping board from the bottom of the printer.
- Position printer so that the bottom of the base pan is accessible.
- It is mandatory that the two protruding pan head shipping screws be removed prior to placing this printer into operation.
- The voltage and frequency to be applied must agree with that called out on the label near the power cord receptable.

For shipping instructions, see Maintenance Manual:

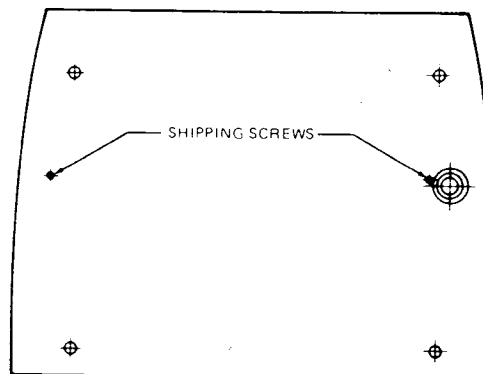



# PAPER LOADING

To load paper refer to diagram of Printer Components and proceed as follows:

- Set the PRINT switch to the OFF position.
- Open the top cover lid and set the form thickness lever to “5”.
- Rotate the tractor mechanism up to the load position. Open both of the bottom paper hold-downs.
- Grasp the leading edge of the paper, pull it under the tractor mechanism (printing side down), then fold it up and on to the left and right tractors. Close both bottom paper hold-downs, then lower the tractor mechanism to the operating position.
- Should the form width not match the tractor spacing, loosen the tractor locking knobs on the left and right tractors so that the sprockets match the paper holes, then tighten the locking knobs.
- Using the paper advance knob, advance the paper while guiding it under and around the platen up past the print head. (The ribbon cartridge may be removed to give more clearance at the print head.)
- Open both of the upper paper hold-downs.
- Set the PRINT switch to ON, then to OFF; then momentarily press FORM FEED. This sets the line counter.
- Manually advance paper to the top of the next form leaving space to fit the format as desired. (Characters are printed about 1/8 inch below the top edge of the print head.)
- Adjust the form thickness lever for optimum print quality. (Adjust while printing if necessary.)
- Close the cover lid.
- Set the PRINT switch to ON. The printer is now ready to receive and print data.

## PRINTER COMPONENTS

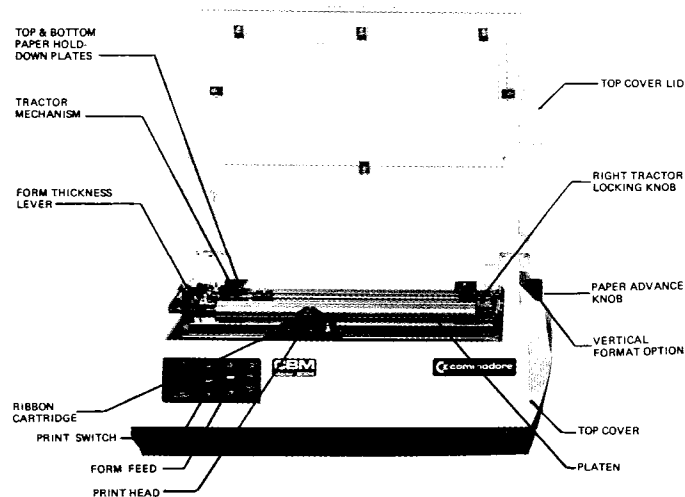

## RIBBON CHANGING

The ribbon cartridge can be changed with paper loaded in the printer. To change the cartridge proceed as follows:

- Set the PRINT switch to OFF.
- Set the form thickness lever to "5."
- Raise the top cover.
- Remove the old ribbon cartridge.
- Before installing the new cartridge, remove wire transit pin, turn its ribbon advance knob clockwise to remove any slack in the ribbon.
- Tip the front of the cartridge down and slip the ribbon between the print head and the platen (or paper). Pull the cartridge back to allow it to clear the print head assembly and snap the cartridge into place over the guide pins.
- Manually advance the ribbon to remove slack and observe that the ribbon tracks properly through the slot in the print head.
- Close the top cover.
- Set the form thickness lever for optimum print quality. (Adjust while printing if necessary.)

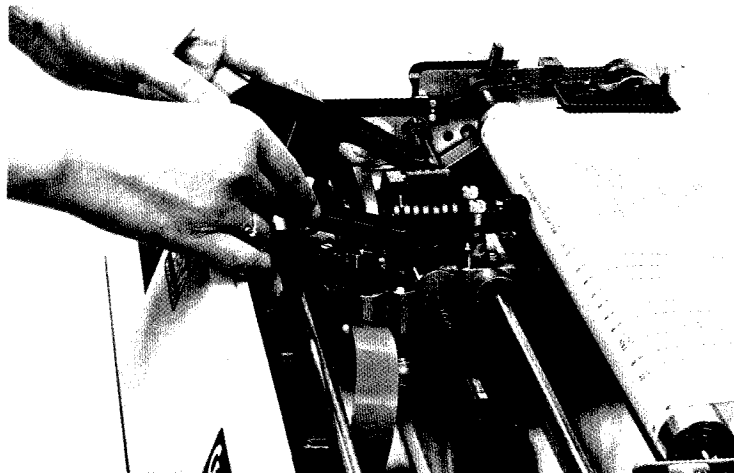

**How to change Ribbon**

# CONTROLS/INDICATORS

## CONTROLS

### AC Power ON/OFF

The AC Power control applies to the printer. When set to the ON position the printer completes an initialization cycle, and the POWER ON indicator lights.

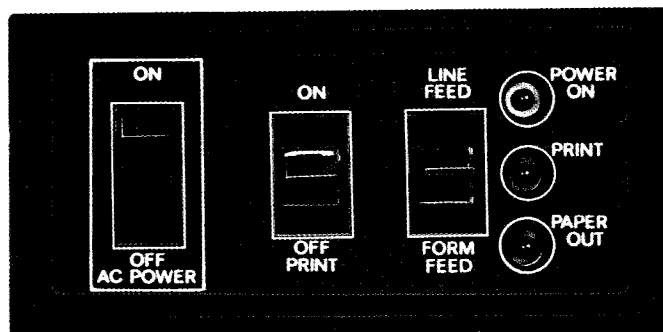

### Print ON/OFF

After the POWER ON indicator lights, set the PRINT ON control. This will light the PRINT indicator. The printer is now ready to print. Thereafter certain options permit disabling and enabling by control code command.

## WARNING

TO PREVENT POSSIBLE INJURY, TURN THE PRINT SWITCH OFF BEFORE RAISING THE TOP COVER.

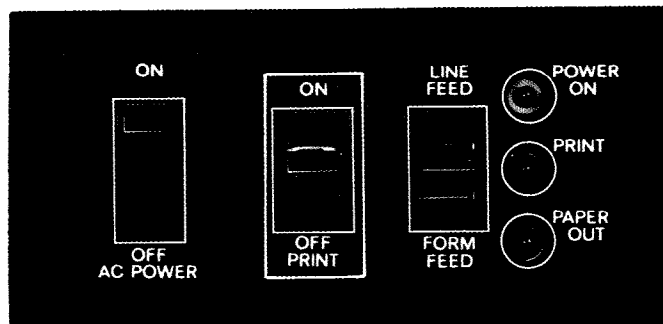

## Form Feed/Line Feed

This control is a momentary rocker switch. Momentarily placing the switch in the FORM FEED position causes paper to advance to the top of the next form. Momentarily placing the switch in the LINE FEED position causes paper to advance one line. Holding the switch in either position causes paper to advance continuously. When the switch is released from FORM FEED position, paper motion stops at the top of the next form. When the switch is released from LINE FEED position, paper motion stops at the next line. The switch is inoperative when the PRINT switch is energized.

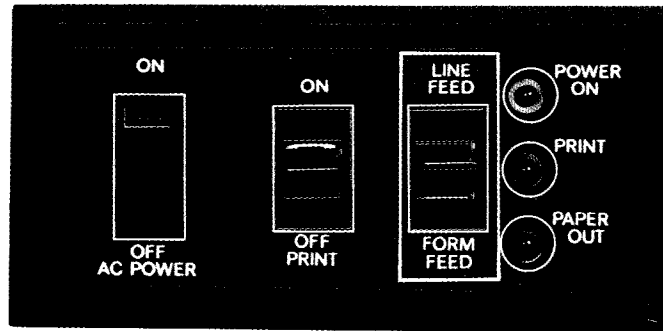

## Forms Thickness Control

The FORMS THICKNESS CONTROL is a five position lever that controls the distance between the print head and platen for various (pack) thicknesses.

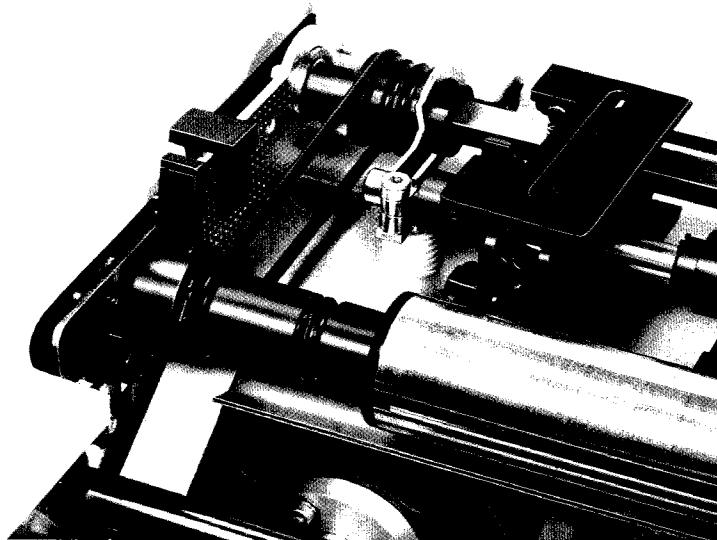

## Forms Width Control

Both the right and left tractor mechanisms are adjustable for various form widths. Both tractors have locking knobs that hold the mechanisms in any preselected position for forms from four to fifteen inches wide.

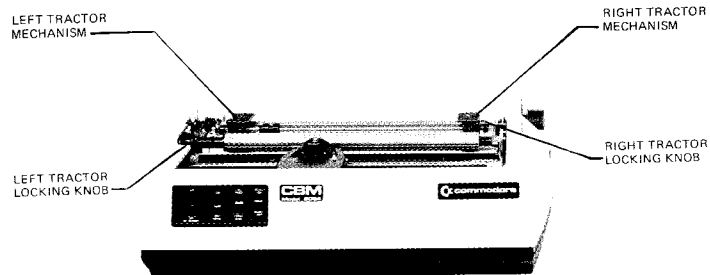

## 6/8 Lines Per Inch Vertical Format Controls

The vertical format controls are attached to a mounting plate on the right side of the printer. The 6/8 LPI selector is part of a three-position switch used to select a printout of either 6 or 8 lines of print per lineal inch of paper. (The third position is used for self-test.)

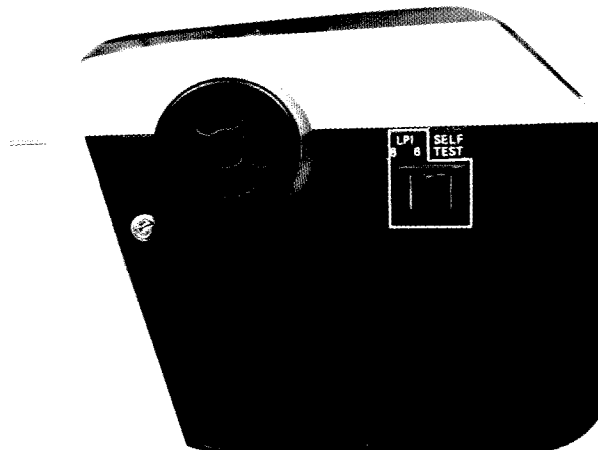

## Self-Test

The self-test control adds a third position to the 6/8 LPI (Vertical Format) switch. The far right switch position is thus labeled SELF-TEST. If the 6/8 lines per inch vertical format option is not present, the self-test option requires a two-position toggle switch at this same switch location. The two positions are labeled OFF and SELF-TEST.

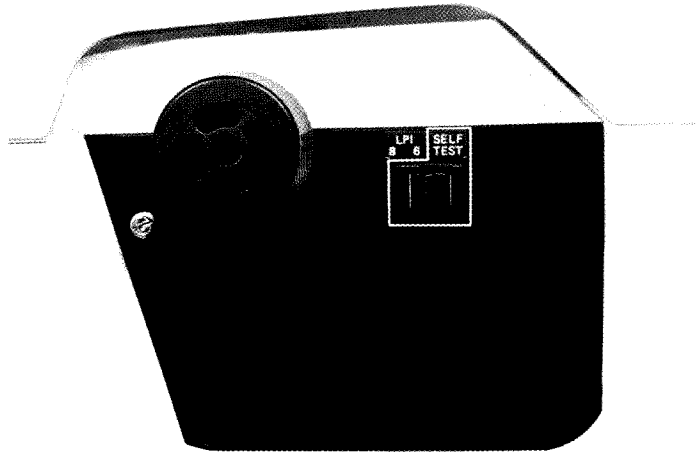

# INDICATORS

## Power On

The POWER ON indicator illuminates when power is applied to the printer and the power switch is set to the ON position.

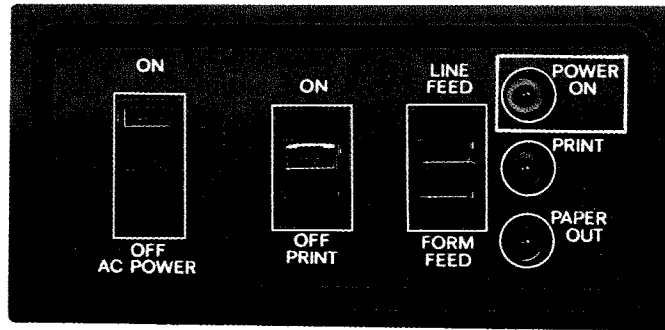

## Print

The PRINT indicator illuminates when the printer is on line.

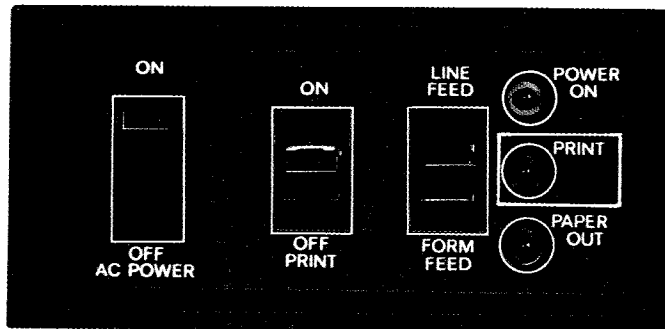

## Paper Out

The PAPER OUT indicator illuminates when 3 inches of paper are left in the paper supply.

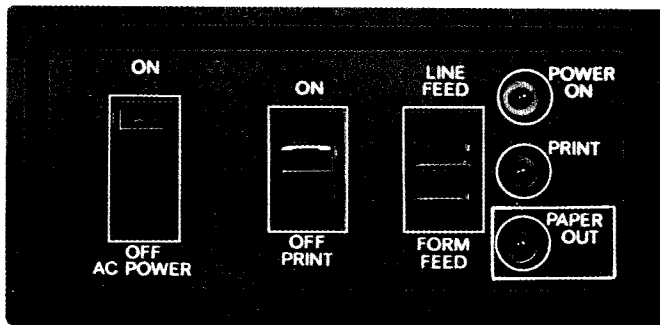

# OPERATING INSTRUCTIONS

## Audio Alarm

The alarm sounds when the printer has run out of paper or if a printer malfunction occurs causing the print head to make contact with the left or right limit switch. If it's case of running out of paper refer to paper loading instructions and reload paper supply. If the latter occurs, the printer can be reset by centering the print head away from the limit switches and setting the power switch to OFF for five seconds and then returning the switch back to the ON position.

## Using the 8024 Printer

For use and software control of the 8024, see comodore manual 32038-2.

# SELF-TEST PROCEDURES

The self-test verifies the operation of the international electronics of the printer and thus is an aid to isolation of system problems. Perform the printer self-test as follows:

1. Check to see that the printer is properly loaded with paper.
2. Set the power switch to ON.
3. Set the Self-Test switch to SELF-TEST.
4. Set the Print switch to ON. The printer should continuously print 66-line test-patterns until the Print switch is set to OFF.
5. Set the Print switch and the Self-Test switch to OFF.
6. Call your supplier if the test pattern is not identical to the following example:

**NOTE: The standard printer is programmed for a 60-line printout and a 6-line bottom-of-form skip.**





# OPTIONS

## **Bottom Feed**

The bottom feed option allows paper to enter the printer from either the bottom or rear of the machine (not applicable with other options except Red/Black printing).

## **Quick Forms Access (Factory or Field installable)**

(Not applicable with other options except Red/Black printing.)

This option will accommodate variable width forms from 4 to 15 inches wide. The "quick tear" facility allows the operator to tear off a form immediately above the printed line, thus minimizing paper wastage in real time applications.

### Operation

The paper is loaded through the lower tractors in the normal manner. The paper then passes around the platen and between the pinch rollers. The pinch rollers are closed and the tear bar lowered. After closing the lid, printing may begin. Best operation is achieved if every form is torn off after printing.

A stepped pulley is provided to operate the pinch rollers at two different speeds. The smaller diameter will drive the rollers faster and should be used with multi-part forms. The larger diameter will usually provide better results with single part paper. To change the speed, simply move the round elastic drive belt from one groove to the other.

If the tear bar is used, the shortest distance from the top of the form to the bottom of the first printed line is 1.5 inches. If the form is perforated, it may be torn below the tear bar as close as 1.19 inches (T. O. F. to bottom of first printed line).

To operate in the continuous form mode, i. e. no forms to tear off, the paper by-passes the rollers and is routed through the top tractors as per normal operation.

### Form Requirements

Successful operation of this option is highly dependant on the integrity and attachment method of the forms. However, it is known, that other form combinations than those listed may successfully be used. This list is a basic guide. Each application must be judged upon its own merits and must be implemented only after satisfactory form trials have been completed.

The option operates successfully with forms that fall within the following categories of thickness and weight:

1. 1 part 15 – 20 lb. bond (.0030" – .0040" thick)
2. 2 to 4 part 12 – 20 lb. bond (.0024" – .0040" thick) with 8 lb carbon (.0011" thick) edges must be securely attached.
3. 5 part 11 1/2 lb. bond (.002" thick) with 3 lb. carbon (.0011" thick) edges must be securely attached.

### Description (Ref. Fig. 19)

The option consists of a set of pinch rollers that are mounted on the print mechanism side frames and driven by the paper advance mechanism. A tear bar is provided. The rollers may be opened to release the paper by means of a lever.

A slot is cut in the window of the lid of the printer to facilitate access to the printed forms.

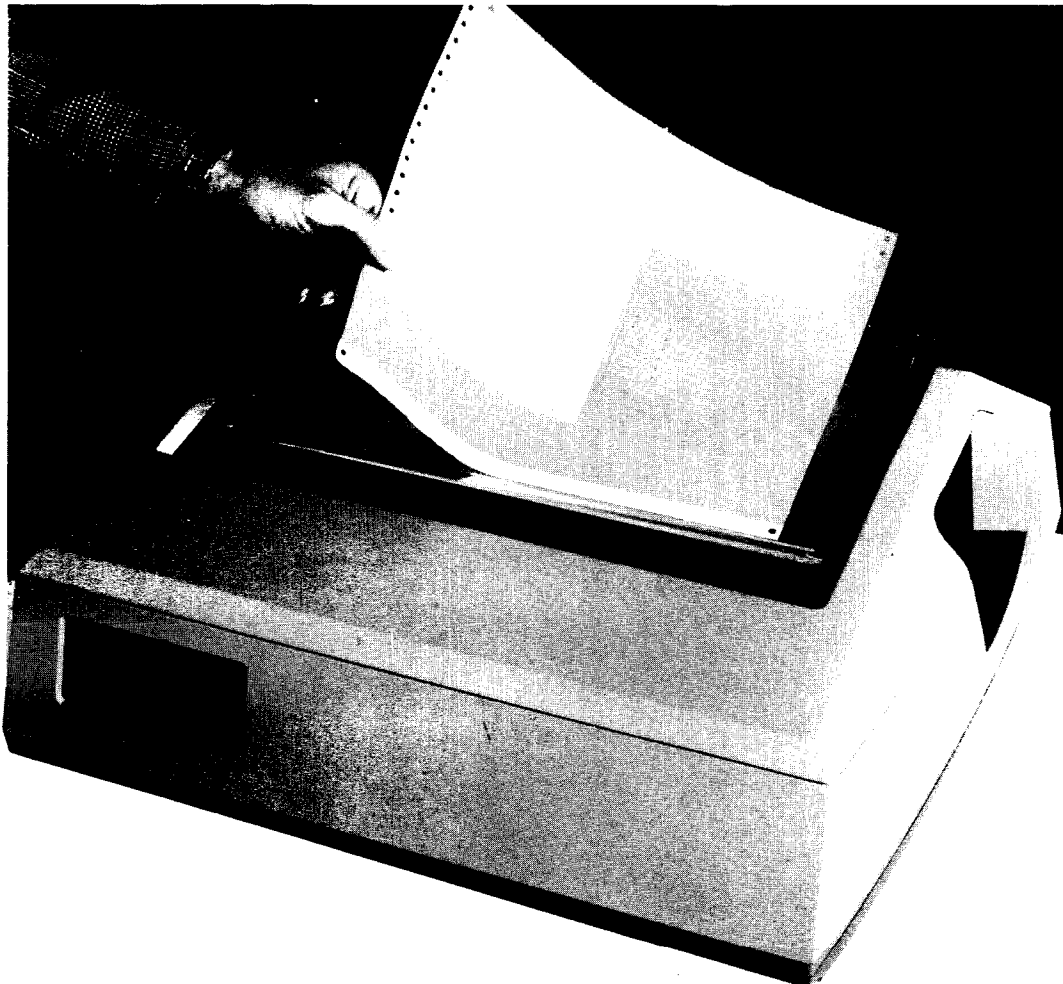

#### Exceptions and Disclaimer

If multi-part forms of light weight paper are not properly edge crimped or glued, the last copies may tend to bunch up behind the platen. For this reason, not all forms that fall into the weight and thickness specification will work.

At least every third form must be torn off. An even pressure and brisk tearing action will help maintain form alignment.

#### Printer Noise

The printer noise will be less than 63 dB(A) with 25% printing duty cycle on single part paper. The higher noise level is due to the opening in the window. Noise level on STD printer will be less than 55 dbA.

#### Environmental

This option will in no way alter the environmental margins as specified in the basic engineering specification.

#### Red/Black Printing Option

(Not applicable with AFF-option.)

This option allows the user to print data either in red or in black. It is a factory installed option.

The switching codes are:

- Red color printing: chr\$ 130
- Black color printing: chr\$ 02

Power on default is black color printing.

### **Automatic Front Feed (AFF)**

Available only with option package.

Once the paper is loaded in the AFF all paper motion commands which would cause movement of the print platen, are ignored.

Before the AFF-commands are executed, all data in the buffer up to the AFF-command is printed, then the AFF-command is processed.

Data which was still in the buffer after the AFF-command was executed will then be printed.

The option is mounted on a slide bar in such a way that it may be positioned to any block or area across the page. A cut form is manually introduced to the two transport rollers and insertion is accomplished via a command from the host. Printing will occur on all paper motion commands as outlined in this manual. Vernier paper adjustment may be accomplished by the use of two sliding paper guides within the unit. An optical line finder is available as an additional option.

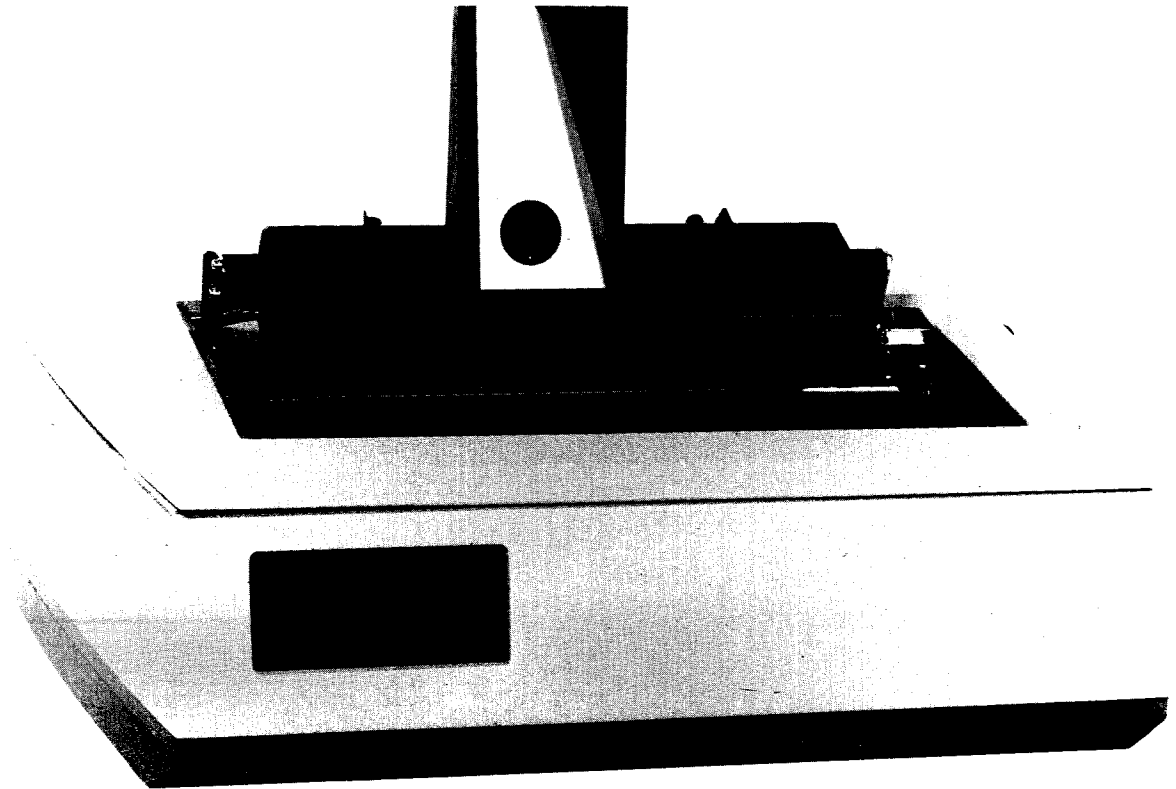

The forms to be used with this option should be bottom glued and not be more than 12 inches in length with a thickness of .023 inches maximum. Form width should be a minimum of 5.27 inches (132 mm) and a maximum of 11.73 inches (298 mm). The distance from the top of the form to the first printable line is .9 inches.

The AFF lead in code is (chr\$ [27])

– INSERT COMMAND – Insert (ASCII = O)

If a page format has been set, this command will cause the form to be driven directly to the line one position as specified by the set format instructions.

If no page format has been set, the insert command will drive the form to the top absolute margin. The top absolute margin is at the distance along the form from the form's sensor to the print head.

– EJECT COMMAND – Eject (ASCII = P)

Upon the receipt of the eject command, the form will be driven out of the rollers, allowing removal of the form by the operator.

Any eject commands sent to the 8024 after an eject and prior to an insert command will cause the unit to try to eject a form of maximum length.

– STEP FORWARD – (ASCII = A)

Form is moved 1/144 inch forward.

– STEP REVERSE – (ASCII = B)

Form is moved 1/144 inch reverse.

– LINE FEED FORWARD – (ASCII = C)

Form is advanced one line, as defined by "select line spacing".

- LINE FEED REVERSE – (ASCII = E)  
Form is reversed one line, as defined by “select line spacing”.
- GO X LINES FORWARD – (ASCII = J·NNN) NNN is valid from 000 to 127  
Form is advanced in line increments as defined by “NNN”.
- GO X LINES REVERSE – (ASCII = K NNN) NNN is valid from 000 to 127  
Form is reversed in line increments as defined by “NNN”.
- GO TO X LINE – (ASCII = L NNN) NNN is valid from 001 to 127  
Form is driven forward or reverse as necessary to stop at the line defined by “NNN”.  
Note, that this command is not valid when the insert, using the option line finder command, has been used. Results will be unknown.
- GO X STEPS FORWARD – (ASCII = M NNN) NNN is valid from 000 to 255  
Form is advanced in increments of 1/144 inch as defined by “NNN”.
- GO X STEPS REVERSE – (ASCII = N NNN) NNN is valid from 000 to 255  
Form is reversed in increments of 1/144 inch as defined by “NNN”.

– SET FORMAT – (ASCII = R NNN NNN) NNN is valid from 000 to 127

This command is used to set the top and bottom margins to any required position. The first three digits following the ASCII R correspond to the position to which line one is to be set, counting from the bottom edge of the form. If these three digits are 000, line one will be set to the top absolute margin.

The second three digits correspond to the length of the bottom margin counting from the bottom edge of the form.

Note that this command may not be issued after an insert and prior to an eject. Also be aware that the set line spacing command, if set to a different value, will cause a different number of lines per form and if the set format command is unchanged, will produce different results.

– SET LINE SPACING – (ASCII = S NNN) 018 – 127

Normal response – this command sets the number of steps (one step = 1/144 inch) that will be taken during any line feed/move operation (i. e. 6 lpi is set to 024 steps, 8 lpi is set to 017 steps, etc.). Upon power up, the line spacing will be set to 6 lpi.

Note that this command may not be issued after an insert and prior to an eject. This command also changes the number of lines per form.

– OPTICAL LINE FINDER OPTION – (ASCII = F)

Insert using the optical line finder command.

Receipt of the insert to next printable line command (ASCII F) will drive the form to the line following the last printed line containing two dashes at the left edge of the form.

These dashes must be within one millimeter of the left edge of the form and not less than one line above the absolute bottom margin.



Note: Pre-printed forms must not have any printed marks or sprocket holes in the left margin area. Also the left mechanical paper guide must be positioned all the way to the left, to enable the optical sensor to detect the paper's top edge.

If the optical line finder option is not installed, this command will cause the sonalert to sound.

– ASCII D = Automatic Insert

When the host sends this command, the unit will automatically insert the sheet approximately one second after manual input of the form.

– ASCII G = Subscript (8 steps)

– ASCII H = Upperscript (8 steps)

– ASCII I = Tab with optical line finder option

– ASCII T = Unit makes selftest

– ASCII U = Automatic optical line finder insert

– ASCII V = Reset (Unit can be reset by this instruction)

EXAMPLES: CNTRL T + "O" . . . . . Insert  
          CNTRL T + "C" . . . . . Line feed up  
          CNTRL T + "P" . . . . . Eject

NOTE 1: ASCII characters sent to the front feed can be either upper case or lower case.

NOTE 2: Optical line finder commands are only valid if this option is installed.

# AUTOMATIC FRONT FEED ASSEMBLY

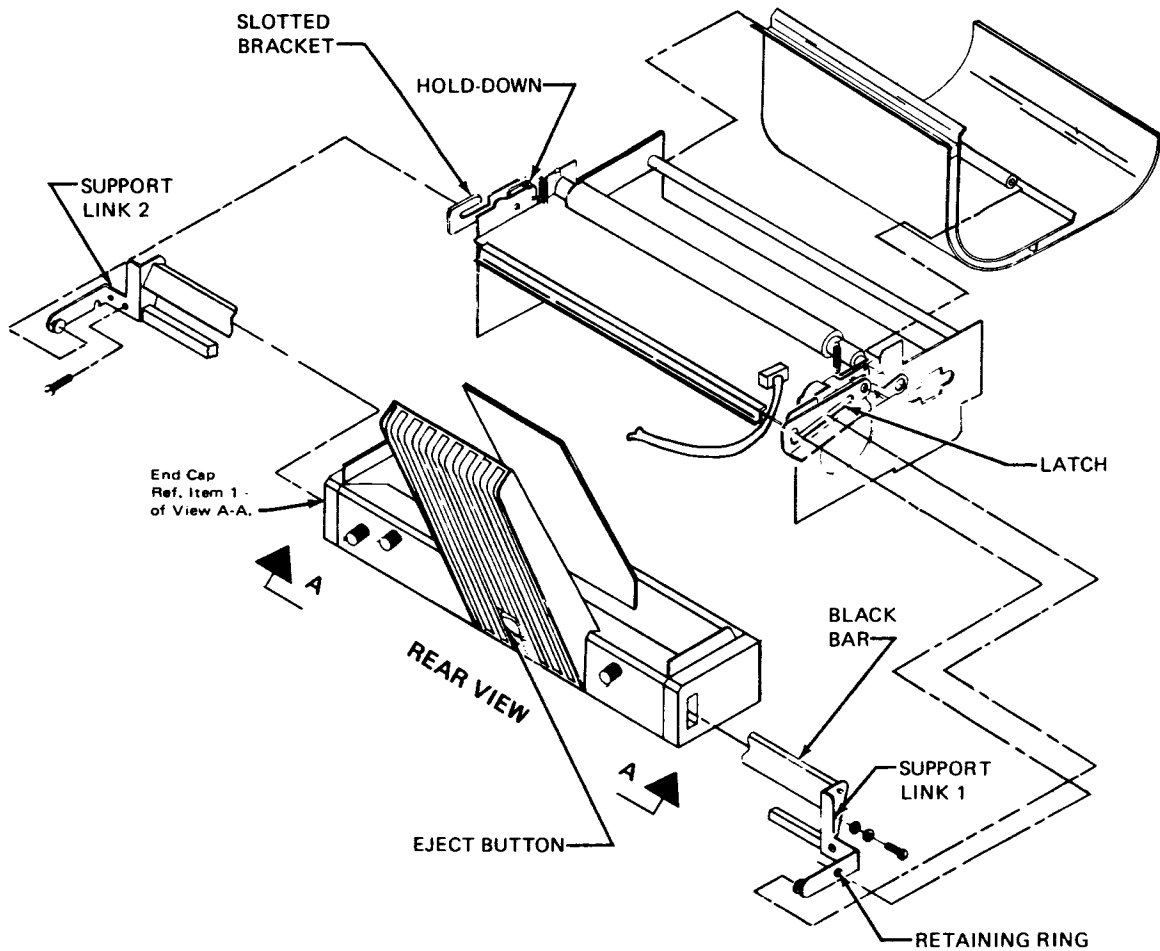

## SPECIFICATIONS

### - Dimensions

Height: 8.5 inches (216 mm)  
Depth: 3.9 inches (99 mm)  
Width: 13.7 inches (348 mm)  
Weight: Approximately 5 lbs (2.3 kg)

### - Power Source

- + 5V, .5 Amp Logic Supply
- + 18V, 2.2 Amp (3.2 Amp Peak) Operating Motor Supply
- .3 Amp (1.0 Amp Peak) Standby Motor Supply

– Form Thickness

Cut Single Forms: Minimum – 70 g/m<sup>2</sup>  
Maximum – 180 g/m<sup>2</sup>

Cut Multi-Part Forms: Multiple form sets must be bottom glued  
First and last page – 70 g/m<sup>2</sup> minimum  
Total pack thickness not to exceed .023 inches (0.6 mm).

– Transport Speed

Slew rate 7.5 inches/second changing

– Vertical Spacing

1/144 inches per step

18 steps at 8 LPI

24 steps at 6 LPI

18 to 127 steps per line (programmable)

18 to 60 steps when using the additional option of the optical line finder

– Top Margin

The distance from the top edge of the paper to the first printable line is .9 inches (22.9 mm).

# PRINT QUALITY

## NORMAL

— Printing — Data Processing Quality (Normal Print)

Character font: 9 x 7

4 out of 7 horizontal dots

9 vertical dots

Character set: 96 US ASCII + 32 international

The print head prints at 200 characters per second. After completing a line of print, it moves to the nearest end of the next print line and prints left to right or right to left as required.

## NLQ

— Printing — Correspondence Quality

Whenever the 8024 has entered the word processing mode, correspondence quality print is produced.

It is produced by two passes of the printhead over the characters, shifting the needles 1/2 a dot diameter vertically between passes. This produces a character with 18 vertical dots per 0.1 inch.

Horizontally, the printhead moves at a rate of 10 inches per second with a needle frequency of 1,000 impacts per second. This is equivalent to allowing 10 printable dots per 0.1 inch out of a possible 40 defined dot positions. The print speed in each of the two passes is 100 cps.

## DRAFT

## NLQ

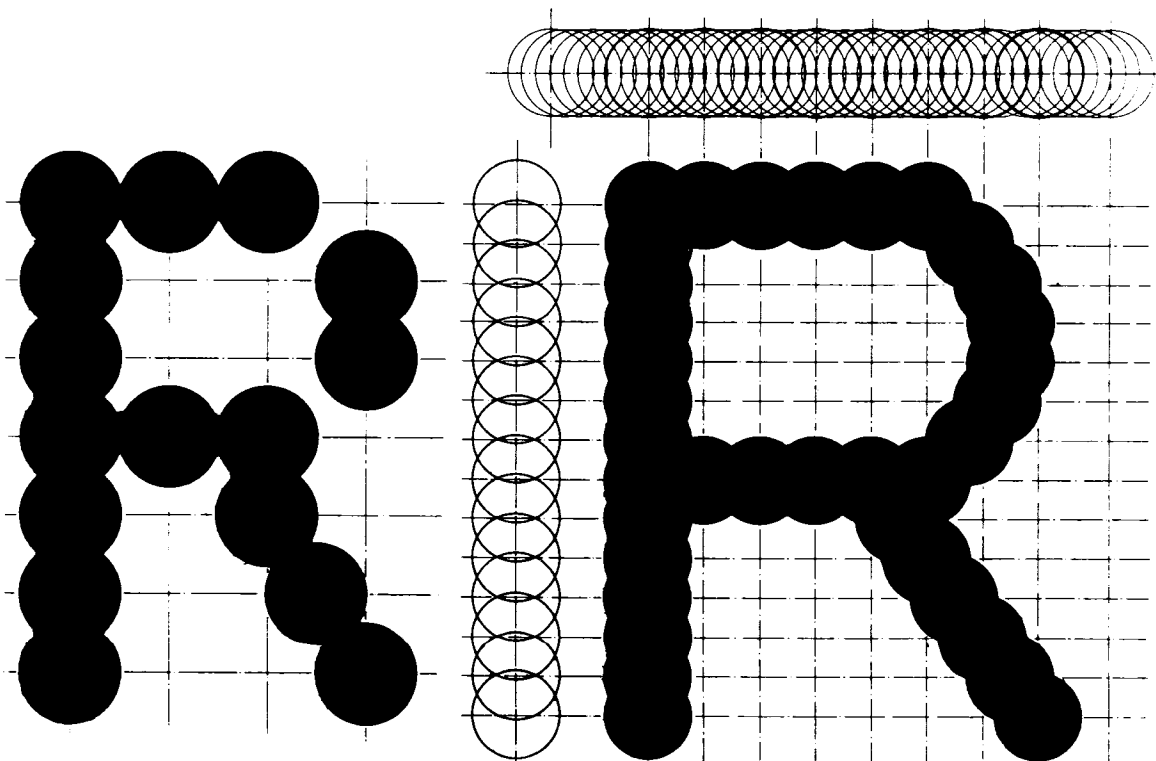



# 8024 IEEE-488 INTERFACE

## Table of Contents

|  | Page No. |
|--|----------|
| 1.0 GENERAL DESCRIPTION                    |          |
| 1.1 Overview _____                         | 30       |
| 1.2 Interface circuits _____               | 30       |
| 1.3 Printer operation _____                | 30       |
| 1.4 Packaging _____                        | 30       |
| 2.0 FUNCTIONAL DESCRIPTION                 |          |
| 2.1 NRFD hold off mode _____               | 30       |
| 3.0 OPERATIONAL DESCRIPTION                |          |
| 3.1 Setting address switches _____         | 30       |
| 3.2 Secondary addressing _____             | 31       |
| 3.3 Data transfer _____                    | 32       |
| 3.4 Printer control characters _____       | 33       |
| 3.5 Interface connections to printer _____ | 34       |
| 3.5.1 IEEE 488 _____                       | 34       |
| Addendum option package A _____            | 35       |

## **1.0 GENERAL DESCRIPTION**

### **1.1 OVERVIEW**

The GPIB interface is designed to meet the requirements of the IEEE 488 standard. The IEEE 488 standard defines the following general functions:

- Controller (host) function
- Talker (input to host) function
- Listener (output from host) function

The 8024 interface utilizes the listener only function and operates in the NRFD hold off mode.

### **1.2 INTERFACE CIRCUITS**

The 8024 GPIB I/O contains all the necessary interface and logic circuits to connect a 8024 to a system GPIB bus. These interface circuits comply with IEEE standard 488 in regard to signal level, termination and power up/down requirements.

### **1.3 PRINTER OPERATION**

8024 printers with a GPIB I/O are designed for applications such as programmable measurement instrument systems, small business systems and general purpose minicomputer systems. The printer operates in the Listen Only mode responding to commands from the system controller. Data and Print Control characters are PET and ASCII. Data transfer rates are 75 kilobytes maximum. Actual transfer rates are determined by system variables.

### **1.4 PACKAGING**

The GPIB I/O consists of a single printed circuit board assembly with cables for connection to the basic printer module and the rear mounted GPIB bus connector.

## **2.0 FUNCTIONAL DESCRIPTION**

### **2.1 NRFD HOLD OFF MODE**

(Refer to figure 1 & 2.) The figure operates in the NRFD hold off mode only. Printer status i.e. paper out, off line, fault and printer busy functions are monitored as a single response on the NRFD line of the IEEE 488 interface. Data may be transferred to the printer, when NRFD is in a ready state. Service request (SRQ), remote enable input (REN) and end or identify (EOI) are not utilized in this mode. However, the "unlisten" command is accepted and puts the printer in the "LIDS" state.

## **3.0 OPERATION DESCRIPTION**

### **3.1 SETTING ADDRESS**

A group of jumpers are mounted on the edge of the P.C.B. assy to facilitate address selection. Five jumpers are utilized for My Listen Address, L1 thru L5. My Listen Address (MLA) may be selected from 32 decimal to 62 decimal. The unit is shipped from the factory with MLA set to 36 decimal.

## 3.2 SECONDARY ADDRESSING

Secondary addressing allows control of the format capabilities. Once the primary listen address has been sent to the printer a secondary address may be sent to select one of the following modes.

### 3.2.1 MODE 0, SECONDARY ADDRESS DECIMAL 96

In this mode data will be printed exactly as received.

### 3.2.2 MODE 1, SECONDARY ADDRESS DECIMAL 97

Print data in accordance with format loaded in mode 2. If no format is present, data will be printed as received.

### 3.2.3 MODE 2, SECONDARY ADDRESS DECIMAL 98

Store the format data. Data characters following this command are sequentially loaded in the printer formatter. A carriage return character terminates the format load cycle. The format consists of alpha and numeric fields separated by blanks (spaces).

| LOADED FORMAT FIELD | DATA TO PRINTER | PRINTED RESULT |
|---------------------|-----------------|----------------|
| AAAAA               | ABC             | ABC            |
| AAAAA               | ABCDEFG         | ABCDE          |
| \$\$\$\$\$          | 99              | \$99           |
| \$9999              | 99              | \$99           |
| \$99.99             | 77              | \$77.00        |
| \$99.99             | -77             | \$77.00        |
| \$99.99-            | -77             | \$77.00-       |
| \$99.99-            | 77              | \$77.00        |
| S\$99.99            | 77              | +\$77.00       |
| ZZZZ                | 77              | 0077           |
| ZZ.999              | 77              | 77.000         |
| ZZZ.99              | 77              | 077.00         |
| 999.99              | 77              | 77.00          |
| .99                 | 77              | **             |
| .99                 | .001            | .00            |
| S.999               | 1.5E-02         | +0.015         |
| Z.999-              | 1.5E-02         | 0.015          |
| Z.999-              | -1.5E-02        | 0.015-         |
| \$999.99            | 7.77            | \$7.77         |

Alphas and numerics may not be combined in the same field.

Example: 99A9 (illegal field definition).

- 9 - Specifies a digit position in a numeric field. If there is no digit to print in this position, then a blank is substituted.
- Z - Also specifies a digit position in a numeric field. Unlike the 9, this character forces a 0 to be printed if there is no digit available for this position. This is desirable if leading zeros are required in a numeric field.
- \$ - If one \$ is specified, then the field is treated as a dollar amount with a fixed dollar sign position:  
 \$123  
 \$1234.00 and so on.  
 If all digit positions to the left of a decimal point are \$, then the number is printed as a floating dollar sign right justified before the most significant digit.
- S - When preceding a numeric field, the sign of the number (+ or -) is to be printed in this fixed column position.



- . – Defines the position of the decimal point and is printed literally in this position.
- – Specifies a trailing sign. If the number is +, a blank is printed. A numeric field cannot have both S and –. When this is the case, only the S will be honored.

Here are some examples of format fields:

- a) Field width and decimal position specified –  
 99 Two-digit integer with no sign  
 99.999 Five digit real type with 3 positions to right of decimal
- b) Dollar sign insertion –  
 \$99.99 Fixed dollar sign  
 \$\$\$99 Floating dollar sign
- c) Leading zeros forced –  
 ZZZZ No decimal  
 ZZ.99 Decimal
- d) Trailing minus –  
 999– Blank is printed, if number is positive
- e) Signed numbers –  
 S99 + or – always printed

The printer formatter handles up to ten significant figures, and an exponent range – or + 99 on numbers passed as data to be formatted. Exponential numbers must be normalized such that  $0 <= / \times / < 10$ . Up to 132 characters are accepted in a format string. Excess characters are ignored.

#### EXAMPLES OF PRINTING PER FORMAT:

##### ALPHA (String data):

The letter A represents one position of an alpha field. Within the field, leading blanks are truncated, the field is left-justified, and it is padded to the right with blanks. Shifted blanks, CHR\$ (160), are not deleted if in the leading positions.

Example:

Print # 1, "A AA AAA"

Print # 2, "CBM" CHR\$ (29) "CBM" CHR\$ (29) "CBM"

Results in: C CB CBM

##### SKIP (Blank):

Simply use blanks where spaces are required:

Example:

Print # 1, "AAA AAA AAA"

Print # 2, "PET" CHR\$ (29) "PET" CHR\$ (29) "PET"

Results in: PET PET PET

If an illegal field has been declared, all data to be printed in this field will be substituted with \*'s.

Formatted and unformatted data may not be printed in the same line.

#### 3.2.4 MODE 3, DECIMAL ADDRESS 99

This mode takes the next characters following secondary address 3 and loads it as the format length. The loaded forms length is selected in place of the standard 66 lines when paging is selected (receipt of decimal 147).

### 3.3 DATA TRANSFER

Once the system controller has placed the selected address on the bus and the attention (ATN) and Data available (DAV) signals are also present, the I/O enters the active listener state.

ASCII coded characters may now be passed to the printer by placing the data bits on the bus and actuating the Data Available (DAV) signal line. After accepting the character, the I/O will allow the Data Accepted (NDAC) signal to go high. If the character was a Print Control character, NRFD signalling will be delayed until function is completed. The bus controller will recognize the I/O's NDAC signalling and will remove NDAV signal which will cause I/O to remove NDAC. (Refer to figure 2.)

Data transfer will continue until the controller sends an Unlisten command (UNL) or an Interface Clear signal (IFC). This returns the I/O from the active listener state to the idle state.

## 3.4 PRINTER CONTROL CHARACTERS

### 3.4.1 DOUBLE WIDTH CHARACTERS

Any printable characters received between the enhance code (decimal 1) and the unenhance code (decimal 129) is a double width character. The maximum number of groups of these double width characters is five per line, any group after the fifth group is ignored.

Example: A, B, D (decimal 1), D, E, F (decimal 129), G, H, I, CR

In the printed line of A through I, characters D, E and F are a group of double width characters.

After a CR the printer always returns to single width. Double width characters in a formatted field are printed single width.

### 3.4.2 PAGING ON/OFF

When the printer powers up a forms length of 66 lines automatically loaded but does not become active until paging is turned on.

These 66 lines include 60 printable lines with a bottom of form/top of form skip of 6 lines. A new forms length may be loaded via secondary address mode 3. The new forms length is loaded immediately and the line position is set to the TOF. Paging off prints continuously without 6 line skip, paging on incorporates 6 line skip plus the page length.

### 3.4.3 SKIP SPACE AND SHIFTED BLANK

When printing data in secondary address 1 mode, a skip space (decimal 29) must be sent to delimit the end of a string being edited to a field. Leading blanks are stripped off a string; therefore, to print a blank alpha field you must transmit a shifted blank (decimal 160). Decimal 224 is also a shifted blank and is treated the same as decimal 160.

### 3.4.4 CARRIAGE RETURN

Two carriage return codes are used to terminate a print statement. CR (with line feed) (decimal 13) and CR (without line feed) (decimal 141).

The table XX shows the relationship of these functions and the actions performed.

| Mode  | Dec. 13<br>(CR/LF) | Dec. 141<br>(CR/NO LF) | ACTION<br>PERFORMED       |
|-------|--------------------|------------------------|---------------------------|
| 0 & 1 | X                  |                        | Print & advance<br>1 line |
| 0 & 1 |                    | X                      | Print only                |
| 2 & 3 | X                  | X                      | Terminate<br>format load  |

Both CR codes return the printer to single width characters.

### 3.4.5 LINE FEED

A line feed code (decimal 10) causes the paper to advance line.

NOTE: The first line feed following a CR (decimal 13) will be suppressed and will cause no action.

### 3.4.6 FORM FEED

A form feed code (decimal 12) causes the paper to move to the top of page. This will occur regardless of paging on or off.

### 3.4.7 BELL CODE

The bell code (decimal 7) will sound the audible alarm for approximately 2 seconds.

### 3.4.8. CHR\$ (14):

Print like the screen of the CBM 8032 model (lower case). Upper case characters possible with the shift key. This code is set at POWER ON, DEFAULT.

### CHR\$ (142):

Should be used in connection printer 8024 with CBM model 3032.

NOTE: With wordprocessing software WP3/WP4 the 8024 should be set to CHR\$ (142) mode. This allows to configure the printer as an ASCII device.

### 3.4.9 CURSOR DOWN

11H: This code will cause lower case print if upper case characters are received.

### CURSOR UP

91H: This code will cause upper case print if lower case characters are received.

### 3.4.10 ALL OTHER CODES

All other codes are ignored and cause no action

## 3.5 INTERFACE CONNECTION TO THE PRINTER

### 3.5.1 IEEE 488

| Contact | Signal line | Contact | Signal line |
|---------|-------------|---------|-------------|
| 1       | DIO 1       | 13      | DIO 5       |
| 2       | DIO 2       | 14      | Dio 6       |
| 3       | DIO 3       | 15      | DIO 7       |
| 4       | DIO 4       | 16      | DIO 8       |
| 5       | EOI         | 17      | REN         |
| 6       | DAV         | 18      | Gnd.        |
| 7       | NRFD        | 19      | Gnd.        |
| 8       | NDAC        | 20      | GNd.        |
| 9       | IFC         | 21      | Gnd.        |
| 10      | SRQ         | 22      | Gnd.        |
| 11      | ATN         | 23      | Gnd.        |
| 12      | SHIELD      | 24      | Gnd.        |

# ADDENDUM OPTION PACKAGE A

**1.0** This addendum should be used only whenever you are using an 8024 printer with option package A.

## 2.0 DEFINITION OF OPTION PACKAGE A

(9 needle head standard)

### 2.1 COMPRESSED PRINT

This feature allows printing at 16.5 CPI, the maximum number of characters/line is 132. This allows to print 132 characters in a line on an 80 column paper.

### 2.2 NLQ-PRINTING

This option allows you to print in a high density matrix and a result is a "near letter quality" printout.

### 2.3 SECONDARY ADDRESS 6

This secondary address allows you to select via the IEEE-bus 6 LPI or 8 LPI printing.

e.g.: open 6, 4, 6

print # 6, chr\$ (24) . . . 6 LPI (DEFAULT at power up)

print # 6, chr\$ (18) . . . 8 LPI

A hardware switch to select 6/8 LPI is no longer provided with this option package.

## 3.0 CONTROL CODES

chr\$ (4) . . . selects 10 CPI printing

chr\$ (133) . . . selects 16,5 CPI printing

## 4.0 NLQ SELECTION

To select either the NLQ print mode or the DRAFT-mode a hardware switch at the right hand side of the printer is provided.

This switch has three functions:

- a) Selftest
- b) DRAFT-printing
- c) NLQ-printing

After you switch back from NLQ to the DRAFT-mode the printer will revert to 10 CPI printing regardless if 10 or 16.5 CPI was selected before.

# COMMODORE 8024

## CONTROL CODE SUMMARY

|    | CODE       | FUNCTION                 | ASCII | KEY          |
|----|------------|--------------------------|-------|--------------|
| 1  | CHR\$ (1)  | DOUBLE WIDTH             | SOH   |              |
| 2  | CHR\$ (2)  | BLACK                    |       |              |
| 3  |            |                          |       |              |
| 4  | CHR\$ (4)  | 10 CPI                   |       |              |
| 5  |            |                          |       |              |
| 6  |            |                          |       |              |
| 7  | CHR\$ (7)  | BELL                     | BEL   |              |
| 8  |            |                          |       |              |
| 9  |            |                          |       |              |
| 10 | CHR\$ (10) | LINE FEED                | LF    |              |
| 11 |            |                          |       |              |
| 12 | CHR\$ (12) | FORM FEED                | FF    |              |
| 13 | CHR\$ (13) | CARRIAGE RETURN (CR+LF   | CR    | RETURN       |
| 14 | CHR\$ (14) | CBM 8032                 | SO    |              |
| 15 |            |                          |       |              |
| 16 |            |                          |       |              |
| 17 | CHR\$ (17) | LOWER CASE (CURSOR DOWN) | DC1   | CURSOR DOWN  |
| 18 |            |                          |       |              |
| 19 | CHR\$ (19) | PAGING OFF               | DC3   | HOME         |
| 20 |            |                          |       |              |
| 21 |            |                          |       |              |
| 22 |            |                          |       |              |
| 23 |            |                          |       |              |
| 24 |            |                          |       |              |
| 25 |            |                          |       |              |
| 26 |            |                          |       |              |
| 27 | CHR\$ (27) | AFF LEAD IN CODE         | ESC   | ESC          |
| 28 |            |                          |       |              |
| 29 | CHR\$ (29) | SKIP (FORMAT END)        | GS    | CURSOR RIGHT |
| 30 |            |                          |       |              |
| 31 |            |                          |       |              |
| 32 |            |                          |       |              |

|     | CODE        | FUNCTION                 | ASCII | KEY          |
|-----|-------------|--------------------------|-------|--------------|
| 129 | CHR\$ (129) | DOUBLE WIDTH OFF         |       |              |
| 130 | CHR\$ (130) | RED                      |       |              |
| 131 |             |                          |       |              |
| 133 | CHR\$ (133) | 16.5 CPI                 |       |              |
| 134 |             |                          |       |              |
| 135 |             |                          |       |              |
| 136 |             |                          |       |              |
| 137 |             |                          |       |              |
| 138 |             |                          |       |              |
| 139 |             |                          |       |              |
| 140 |             |                          |       |              |
| 141 | CHR\$ (141) | CARRIAGE RETURN W/O FEED |       | SHIFT+RETURN |
| 142 | CHR\$ (142) | CBM 8032 MODE            |       |              |
| 143 |             |                          |       |              |
| 144 |             |                          |       |              |
| 145 | CHR\$ (145) | UPPER CASE (CURSOR UP)   |       | CURSOR UP    |
| 146 |             |                          |       |              |
| 147 | CHR\$ (147) | PAGING ON                |       | CLR          |
| 148 |             |                          |       |              |
| 149 |             |                          |       |              |
| 150 |             |                          |       |              |
| 151 |             |                          |       |              |
| 152 |             |                          |       |              |
| 153 |             |                          |       |              |
| 154 |             |                          |       |              |
| 155 |             |                          |       |              |
| 156 |             |                          |       |              |
| 157 |             |                          |       |              |
| 158 |             |                          |       |              |
| 159 |             |                          |       |              |
| 160 | CHR\$ (160) | SHIFTED SPACE            |       | SHIFT+SPACE  |
| 161 |             |                          |       |              |
| 162 |             |                          |       |              |
| 163 |             |                          |       |              |
| 164 |             |                          |       |              |
| 165 |             |                          |       |              |
| 166 |             |                          |       |              |
| 167 |             |                          |       |              |
| 224 | CHR\$ (224) | SHIFTED SPACE            | E0H   |              |

# PROGRAMMING

## 1. MODES OF OPERATING

The printer has basically 2 modes of operation:

Business mode (small and capital letters)

Graphic mode

When the PWR switch has been turned on or after reset, the printer is working in "Business mode", according to the screen of the CBM 8032-2 or the business models of the CBM 3000 series.

In this mode, unshifted characters will be printed as small characters, all shifted as capital characters. The use of this printer mode is much easier than the use of the CBM 3000 series printer.

There is one problem, namely if a CBM 8024 printer has to be used and the existing program is made for the usage of a 3000 series printer. In order to make upward usage possible the graphic mode was created.

The name "graphic mode" was only created, because the 3000 series is also using this mode.

In graphic mode, all unshifted characters will be printed as capital characters, and all shifted characters will be ignored. The printer is then working like a 3000 series printer in graphic mode.

### Switching commands:

For switching into "graphic mode":

OPEN 4, 4

PRINT 4, CHR\$ (142)

to "business mode"

PRINT 4, CHR\$ (14)

When printing small characters in graphic mode:

Use CURSOR UP or CHR\$ (145) and

CURSOR DOWN or CHR\$ (17)

to switch from capital to small characters or vice versa.

### Samples:

10 OPEN 8, 4

20 PRINT 8, CHR\$ (145); "ONLY CAPITAL LETTERS"

30 PRINT 8, CHR\$ (17); "only small characters"

40 CLOSE 8

The print will look as follows:

ONLY CAPITAL LETTERS

only small characters

The switch to small characters will stay only for one line. If you print the next line in small characters you must repeat the command.

## 2. SECONDARY ADDRESSING

Secondary addressing allows control of the format capabilities. Once the primary list address has been sent to the printer a secondary address may be sent to select one of the following modes.

### 2.1 Mode 0, secondary address decimal 96

In this mode data will be printed exactly as received.

### 2.2 Mode 1, secondary address decimal 97

Print data in accordance with format loaded in mode 2. If no format is present, data will be printed as received.

### 2.3 Mode 2, secondary address decimal 98

Store the format data. Data characters following this command are sequentially loaded in the printer's formatter. A carriage return character terminates the format load cycle. The format consists of alpha and numeric fields separated by blanks (spaces).

| LOADED FORMAT FIELD | DATA TO PRINTER | PRINTED RESULT |
|---------------------|-----------------|----------------|
| AAAAA               | ABC             | ABC            |
| AAAAA               | ABCDEFG         | ABCDE          |
| \$\$\$\$            | 99              | \$99           |
| \$9999              | 99              | \$99           |
| \$99.99             | 77              | \$77.00        |
| \$99.99             | -77             | \$77.00        |
| \$99.99-            | -77             | \$77.00-       |
| \$99.99-            | 77              | \$77.00        |
| S\$99.99            | 77              | +\$77.00       |
| ZZZZ                | 77              | 0077           |
| ZZ.999              | 77              | 77.000         |
| ZZZ.99              | 77              | 077.00         |
| 999.99              | 77              | 77.00          |
| .99                 | 77              | **             |
| .99                 | .001            | .00            |
| S.999               | 1.5E-02         | +.015          |
| Z.999-              | 1.5E-02         | 0.015          |
| Z.999-              | -1.5E-02        | 0.015-         |
| \$99.99             | 7.77            | \$7.77         |

Alphas and numerics may not be combined in the same field.

Example: 99A9 (illegal field definition).

- 9 – Specifies a digit position in a numeric field. If there is no digit to print in this position, then a blank is substituted.
- Z – Also specifies a digit position in a numeric field. Unlike the 9, this character forces a 0 to be printed if there is no digit available for this position. This is desirable if leading zeros are required in a numeric field.
- S – If one \$ is specified, then the field is treated as a dollar amount with a fixed dollar sign position:  
\$123  
\$1234.00  
And so on. If all digit positions to the left of a decimal point are \$, then the number is printed as a floating dollar sign right justified before the most significant digit.
- S – When preceding a numeric field, the sign of the number (+ or -) is to be printed in this fixed column position.
- .
- – Specifies a trailing sign. If the number is +, a blank is printed. A numeric field cannot have both S and -. When this is the case, only the S will be honored.

Here are some examples of format fields:

- a) Field width and decimal position specified –  
99 Two-digit integer with no sign  
99.999 Five-digit real type with 3 Positions to right of decimal
- b) Dollar sign insertion –  
\$99.99 Fixed dollar sign  
\$\$\$99 Floating dollar sign



- c) Leading zeros forced –  
 ZZZZ No decimal  
 ZZ.99 Decimal
- d) Trailing minus –  
 999– Blank is printed, if number is positive
- e) Signed numbers –  
 S99 + or – always printed

The printer formatter handles up to ten significant figures, and an exponent range  $\pm 99$  on numbers passed as data to be formatted. Exponential numbers must be normalized such that  $0 \leq \text{exponent} < 10$ . Up to 132 characters are accepted in a format string. Excess characters are ignored.

**EXAMPLES OF PRINTING PER FORMAT:**

**ALPHA (String data):**

The letter A represents one position of an alpha field. Within the field, leading blanks are truncated, the field is left-justified, and it is padded to the right with blanks. Shifted blanks, CHR\$ (160), are not deleted if in the leading positions.

Example:

Print # 1, "A AA AAA"

Print # 2, "CBM" CHR\$ (29) "CBM" CHR\$ (29) "CBM"

Results:

C CB CBM

**SKIP (Blank):**

Simply use blanks where spaces are required:

Example:

Print # 1, "AAA AAA AAA"

Print # 2, "PET" CHR\$ (29) "PET" CHR\$ (29) "PET"

Results in:

PET PET PET

If an illegal field has been declared, all data to be printed in this field will be substituted with \*\*s.

Formatted and unformatted data may not be printed on the same line.

**2.4 Mode 3, decimal address 99**

This mode takes the next characters following secondary address 3 and loads it as the forms length. The loaded forms length is selected in place of the standard 66 lines when paging is selected (receipt of decimal 147).

**3. PRINTER CONTROL CHARACTERS**

**3.1 Double width characters**

Any printable characters received between the enhance code (decimal 1) and the unenhance code (decimal 129) is a double width character. The maximum number of groups of these double width characters is five per line, any group after the fifth group is ignored.

Example: A, B, C (decimal 1), D, E, F (decimal 129), G, H, I, CR

In the printed line of A through I, characters D, E and F are a group of double width characters.

After a CR the printer always returns to single width. Double width characters in a formatted field are printed single width.

**3.2 Paging on/off**

When the printer powers up a forms length of 66 lines automatically loaded but does not become active until paging is turned on. This 66 lines include 60 printable lines with a bottom of form/top of form skip of 6 lines. A new forms length may be loaded via secondary address mode 3. The new forms length is loaded immediately and the line position is set to the TOF. Paging off prints continuously without 6 line skip, paging on incorporates 6 line skip plus the page length.

### 3.3. Skip space and shifted blank

When printing data in secondary address 1 mode, a skip space (decimal 29) must be sent to delimit the end of a string being edited to a field. Leading blanks are stripped off a string; therefore, to print a blank alpha field you must transmit a shifted blank (decimal 160). Decimal 224 is also a shifted blank and is treated the same as decimal 160.

### 3.4.4 CARRIAGE RETURN

Two carriage return codes are used to terminate a print statement. CR (with line feed) (decimal 13) and CR (without line feed) (decimal 141).

The table XX shows the relationship of these functions and the actions performed.

| Mode  | Dec. 13<br>(CR/LF) | Dec. 141<br>(CR/NO LF) | ACTION<br>PERFORMED       |
|-------|--------------------|------------------------|---------------------------|
| 0 & 1 | X                  |                        | Print & advance<br>1 line |
| 0 & 1 |                    | X                      | Print only                |
| 2 & 3 | X                  | X                      | Terminated<br>format load |

Both CR codes return the printer to single width characters.

### 3.5 Line Feed

A line feed code (decimal 10) causes the paper to advance line.

NOTE: The first line feed following a CR (decimal 13) will be suppressed and will cause no action.

### 3.6 Form Feed

A form feed code (decimal 12) causes the paper to move to the top of page. This will occur regardless of paging on or off.

### 3.7 Bell Code

The bell code (decimal 7) will sound the audible alarm for approximately 2 seconds.

### 3.8. CHR\$ (14)

Print like the screen of the CBM 8032 model (lower case). Upper case characters possible with the shift key. This code is set at POWER ON, DEFAULT.

### CHR\$ (142)

Should be used in connection printer 8024 with CBM model 3032.

NOTE: With wordprocessing software WP3/WP4 the 8024 should be set to CHR\$ (142) mode, this allows to configure the printer as an ASCII device.

### 3.9 Cursor Down

11H: This code will cause lower case print if upper case characters are received.

### CURSOR UP

91H: This code will cause upper case print if lower case characters are received.

### 3.10 All other codes

All other codes are ignored and cause no action

## 4. SAMPLES

### 4.1 Alphanumeric Formatting

Program:

```
10 OPEN 4, 4
20 OPEN 1, 4, 1
30 OPEN 2, 4, 2
40 A$="AA AA AA AA" : REM FORMATSTRING
50 B$="ABC" : REM PRINTED STRING
60 C$=CHR$(29) : REM SKIP
70 PRINT ###4, CHR$(142) : REM SWITCH PRINTER
80 REM CAPITAL CHARACTERS
90 PRINT ###4, A$ : REM PRINTS A$ UNFORMATTED
100 PRINT ###4, B$ : REM PRINTS B$ UNFORMATTED
110 PRINT ##2, A$ : REM PROGRAMMING OF THE FORMATTING
120 PRINT ##1, B$C$B$C$B$C$B$ : REM FORMATTED
130 PRINT ##4, CHR$(12); : REM FORM FEED
140 CLOSE 4
150 CLOSE 1 : CLOSE 2
160 END
```

**Print:**

```
AA AA AA AA
ACB
AB AB AB AB
with form feed
```

### 4.2 Mixed Formatting

Program (made with Business - CBM 8032):

```
10 open 4, 4 : rem normal printout
20 open 1, 4, 1 : open 2, 4, 2 : rem format files
30 f1$="zzzzzzz aaaaaaaaaaaaaaaaaaaaaa 99999.99 szzzzz99"
40 f2$="9999 : rem dual format string
50 f3$=f1$+f2$ : rem strings
60 print ##2, f3$ : rem formatting
70 rem data definition
80 a(1)=532 : n$(1)="Johann Bauer"
90 s(1)=52136.891 : h(1)=-235.6 : z(1)=12
100 a(2)=12589 : n$(2)="Gerhard Einstein"
110 s(2)=8523.99 : h(2)=23.55 : z(2)=562
120 a(3)=4200 : n$(3)="Wolfgang Steinberger"
130 s(3)=16235.8 : h(3)=-31256.888 : z(3)=156230
140 print ##4, chr$(14) : rem switch from capital/small
150 print ##4, "Table 1" : rem unformatted headline
160 print ##4 : rem space line
170 for i=1 to 3 : rem loop
180 print ##1,a(i);n$(i);s(i);h(i);z(i)
190 next
200 print ##4 : rem space line
210 close 4
220 close 1
230 close 2
240 end
```

**Printout:**

Table 1

|          |                      |          |           |      |
|----------|----------------------|----------|-----------|------|
| 0000532  | Johann Bauer         | 52136.89 | -00235.60 | 12   |
| 00012589 | Gerhard Einstein     | 8523.99  | +00023.55 | 562  |
| 0004200  | Wolfgang Steinberger | 16235.80 | -31256.88 | **** |

Instead of the last figure in the last line stars are printed because the figure has 6 digits, but only a 4 digit field was formatted.

# COMMODORE CBM 8024 PRINTER – CONTROL CODE SUMMARY

New Control Code Summary valid for the new enhanced 8024, basic version, version A and B (see last page).

## 6/8 LPI SWITCHING

The new 8024 does not provide any longer a manual switch selection for 6/8 LPI.

If the selection is needed, it could be done with the secondary address 6.

e.g. Open 6, 4, 6

Print #6, chr\$ (18) . . . 8 LPI

or

Print #6, chr\$ (24) . . . 6 LPI

Power on default is 6 LPI printing.

## NLQ-PRINTING

The selection NLQ or draft-printing could be made via the 3-position switch at the side panel.

Position 1: Self-test

Position 2: Draft

Position 3: NLQ

## AUTOMATIC FRONT FEED

The AFF load in code is ESCAPE (chr\$ [27]).

In the following a command summary is given:

**Insert Command** – Insert (ASCII=0)

If a page format has been set, this command will cause the form to be driven directly to the line one position as specified by the set format instructions.

If no page format has been set, the insert command will drive the form to the top absolute margin. The top absolute margin is the distance from the forms sensor to the print head.

**Eject Command** – Eject (ASCII=P)

Upon receipt of the eject command, the form will be driven out of the rollers and thus allow removal of the form by an operator.

Any eject commands sent to the 8024 after an eject and prior to an insert command will cause the unit to try to eject a form of maximum length.

**Step Forward** – (ASCII=A)

Form is moved 1/144 inch forward.

**Step Reverse** – (ASCII=B)

Form is moved 1/144 inch reverse.

**Line Feed Forward** – (ASCII=C)

Form is advanced one line, as defined by "Select line spacing".

**Line Feed reverse** – (ASCII=E)

Form is reversed one line, as defined by "Select line spacing".

**Go X Lines Forward** – (ASCII=J<sup>NNN</sup>) NNN is valid from 000 to 127

Form is advanced in line increments as defined by "NNN".

**Go X Lines Reversed** – (ASCII=K<sup>NNN</sup>) NNN is valid from 000 to 127

Form is reversed in line increments as defined by "NNN".

**Go to X Line** – (ASCII=L<sup>NNN</sup>) NNN is valid from 001 to 127

Form is driven forward or reverse as necessary to stop at the line defined by “NNN”.

Note that this command is not valid when the insert using the option line finder command has been used. Results will be unknown.

**Go X Steps Forward** – (ASCII=M<sup>NNN</sup>) NNN is valid from 000 to 255

Form is advanced in increments of 1/144 inch as defined by “NNN”.

**Go X Steps Reverse** – (ASCII=N<sup>NNN</sup>) NNN is valid from 000 to 255

Form is reversed in increments of 1/144 inch as defined by “NNN”.

**Set Format** – (ASCII=R<sup>NNN NNN</sup>) NNN is valid from 000 to 127

This command is used to set the top and bottom margins to any required position. The first three digits following the ASCII R correspond to the position line one to be set, counting from the bottom edge of the form. If these three digits are 000, line one will be then set to the top absolute margin.

The second three digits correspond to the length the bottom margin counting from the bottom edge of the form.

Note that this command may not be issued after an insert and prior to an eject. Also be aware that the set line spacing command, if set to a different value, will cause a different number of lines per form and if the set format command is unchanged it will produce different results.

**Set Line Spacing** – (ASCII=S<sup>NNN</sup>) 018–127

Normal Response – this command sets the number of steps (one step=1/144 inch) that will be taken during any line feed/move operation (i.e. 6 LPI is set to 024 steps, 8 LPI is set to 017 steps, etc.). Upon power up, the line spacing will be set to 6 LPI.

Note that this command may not be issued after an insert and prior to an eject. Also, this command changes the number of lines per form.

**Optical Line Finder Option** – (ASCII F). Insert using the optical line finder command

Receipt of the insert to the next printable line command (ASCII F) will drive the form to the line following the last printed line containing two dashes at the left edge of the form.

These dashes must be within one millimeter from the left edge of the form and not less than one line above the absolute bottom margin.

Note: Pre-printed forms must not have any printing, marks, or sprocket holes in the left margin area. Also the left mechanical paper guide must be positioned all the way to the left to enable the optical sensor to detect the paper's top edge.

If the optical line finder option is not installed this command will cause the sonalert to sound.

– ASCII D=Automatic Insert. When Master is sending this command, unit will automatically insert the sheet approx. 1 sec. after manual input of the form into the paper tray.

– ASCII G=Subscript (8 steps).

– ASCII H=Upperscript (8 steps).

– ASCII I=Tab with Optical Line Finder Option.

– ASCII T=Unit makes self test.

– ASCII U=Automatic Optical Line Finder Insert.

– ASCII V=Rest. (Unit can be resetted by these instructions.)

Examples: chr\$ (27) + “O” . . . Insert

chr\$ (27) + “C” . . . Line feed up

chr\$ (27) + “P” . . . Eject

Note 1: The ASCII characters sent to the front feed can be either upper case or lower case.

Note 2: The optical line finder commands are valid only if this option is installed.